

R-Line Series 40 Amp Rotary Cam Switches

Rugged and dependable
40 amp switches for
industrial applications



Sprecher + Schuh's rugged R-Line rotary cam switches are available for most control and load applications up to 40 amps. A well thought out ordering system provides many standard and nonstandard configurations, that are often available "off the shelf." Many popular switching configurations are offered from stock.

...For many applications

R-Line control and load switches comply with the most important international standards for use as:

- **Changeover Switches** - for switching between alternate electrical supplies.
- **ON/OFF switches** - to connect and disconnect any electrical supply.
- **Multi-position load switches** - for the step control of loads such as heaters and furnaces.
- **Motor load disconnect switches** - for safely isolating circuits during repair and maintenance.
- **Reversing switches** - to change the direction or rotation of a motor.
- **Wye-Delta switches** - To manually control reduced voltage starting of a motor.

Rugged quality

The R-Line's sturdy design incorporates a positive switching action with a clearly defined switch position. The contact assemblies themselves are brass plated and have generous copper content to help dissipate heat.

Solid connections

The terminal connections are a captive screw design with self-lifting saddle clamps. The saddle clamp design guarantees reliable connections on the R-40. The switch connection terminals are finger safe with IP20 protection.











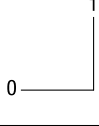

Choose from various switch handle assemblies

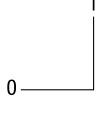

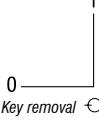

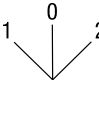

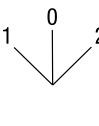
Switch handle assemblies for our Changeover and ON-OFF switches are available with either traditional screw fixing or central nut fixing system. All switch handles offer Type 12 IP66 protection. A UL 4X handle is also available, ordered separately.

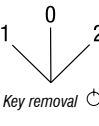
K

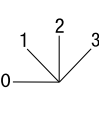
R-Line Rotary Cam Switches

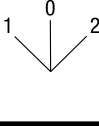
R-Line Front Mounted 40 Amp Rotary Switches with Handle ❶

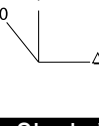
Switch Description				Catalog Number	Price each
Switch Handle Type 12/ IP66 ❸	Function ❷	Switch Angle	Poles/Switch Wafers		
ON - OFF					
 <i>Screw Fixing</i>		90°	1 / 1	RE-40-1751-A	81.08
		90°	2 / 1	RE-40-1752-A	93.19
		90°	3 / 2	RE-40-1753-A	116.86
		90°	4 / 2	RE-40-1754-A	128.76
		90°	6 / 3	RE-40-1756-A	164.54
 <i>Screw Fixing</i>		90°	3 / 2	RE-40-1753-N	131.84
		90°	4 / 2	RE-40-1754-N	143.73
		90°	6 / 3	RE-40-1756-N	179.52
 <i>Central Nut Fixing</i>		90°	2 / 1	RC-40-1752-B	109.03
		90°	3 / 2	RC-40-1753-B	134.99
		90°	4 / 2	RC-40-1754-B	146.99
		90°	6 / 3	RC-40-1756-B	183.11
 <i>Central Nut Fixing</i>		90°	2 / 1	RC-40-1752-DD	138.24
		90°	3 / 2	RC-40-1753-DD	164.19
		90°	4 / 2	RC-40-1754-DD	176.20
		90°	6 / 3	RC-40-1756-DD	212.31
Changeover					
 <i>Screw Fixing</i>		45°	1 / 1	RE-40-3251-A	97.94
		45°	2 / 2	RE-40-3252-A	133.17
		45°	3 / 3	RE-40-3253-A	173.37
		45°	4 / 4	RE-40-3254-A	211.94
 <i>Screw Fixing</i>		45°	3 / 3	RC-40-3253-B	187.41
		45°	4 / 4	RC-40-3254-B	226.03
 <i>Central Nut Fixing</i>		45°	3 / 3	RC-40-3253-DC	216.62
		45°	4 / 4	RC-40-3254-DC	255.24

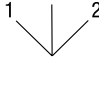

Switch Body Description				Catalog Number	Price each
Switch Handle Type 12/ IP66 ❸	Function ❷	Switch Angle	Poles/Switch Wafers		
Step					
 <i>Screw Fixing</i>		45°	1 / 2	RE-40-5261-A	164.57
Reversing					
 <i>Screw Fixing</i>		45°	3 / 3	RE-40-7303-A	167.95
Wye-Delta					
 <i>Screw Fixing</i>		45°/90°	3 / 4	RE-40-7323-A	210.03
Single Winding (Two Speed)					
 <i>Screw Fixing</i>		45°	3 / 4	RE-40-7293-A	223.81

K
R-Line Rotary Cam Switches

See **Ordering Instructions** on next page. ➡

- ❶ Rated current can be lower depending on application. Check R-Line Technical Section before selecting switch size.
- ❷ See K30 for Circuit Diagrams.
- ❸ See page K8 for description of switch handles.

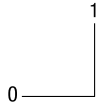
R-Line Base Mounted 40 Amp Rotary Switches with Handle ❶

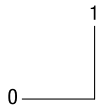
Switch Body Description				Catalog Number ❷	Price each
Switch Handle Type 12/ IP66 ❸	Function	Switch Angle	Poles/ Switch Wafers		
ON-OFF					
 Screw Fixing		90°	3 / 2	RA-40-1753-A	133.06
		90°	4 / 2	RA-40-1754-A	145.06
		90°	6 / 3	RA-40-1756-A	179.70
 Screw Fixing		90°	3 / 2	RA-40-1753-N	148.03
		90°	4 / 2	RA-40-1754-N	160.05
		90°	6 / 3	RA-40-1756-N	194.68

A UL Type 4X switch handle is available for RA-40 switches. First select switch from this page, then turn to Accessories Section (page K27) and order Type R switch handle separately.

Ordering Instructions

RE-40 –		1753 –		A	
Switch Configuration	Circuit Diagram # ❷	Handle Code ❸	for use with		
RE - Front (Panel) Mounted 40 amp switch	1751-1756 ON-OFF	A - Type A	RE/RA switch		
RA - Base Mounted 40 amp switch	3251-3504 Changeover	B - Type B ❹	RC switch		
	5261 Step	N - Type N	RE/RA switch		
	7293 Single Winding	DC - Type DC ❹	RC switch		
RC - Front (Panel) mounted Central Nut fixing	7303 Reversing	DD - Type DD ❹	RC switch		
	7323 Wye-Delta				

Catalog numbers include a complete switch and handle kit.





❶ Rated current can be lower depending on application. Check R-Line Technical Section before selecting switch size.



❷ See K30 for Circuit Diagrams.

❸ See page K8 for description of switch handles.

❹ Not available on RA-40 Base Mounted switches.

R-Line Switch Accessories

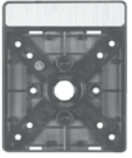
Accessory	Description	Catalog No.	Price
 (Reducer not included)	Replacement Shaft for RE switch (One supplied with each LE switch)	L2-G3380	5.47
	Standard knob 37.5 mm Black Red	L2-G3154N L2-G3154R	3.95 4.11
	48 mm Black Red	L2-G3155N L2-G3155R	4.73 4.73
	Padlockable knob Black Red	L2-G2864N L2-G2864R	8.41 8.41
	Self-contained knob allows mounting RE-40 switches without Switch Handle Assembly IP40 protection IP65 protection	L2-G2851N L2-G2854N	8.21 10.90
 LFS2-N	"ON-OFF" Switch Handle Assembly Type 12, IP66, accepts 3 padlocks Yellow and Red Gray and black	LFS2-N-6-175 LFS2-G-6-175	25.30 25.30
	Type R "ON-OFF" Switch Handle Assembly ①② Screw fixing. Type 3R, 3, 12, 4, 4X, and IP66 Black and Black Yellow and Red	LA7-SB LA7-SY	See page L9
	Type R "ON-OFF" Switch Handle Assembly ①② Screw fixing. Type 3R, 3, 12, 4, 4X, and IP66 Black and Black Yellow and Red	L11-PB L11-PY	See page L30

Accessory	Description	Catalog No.	Price
	Front frame (blank nameplate)	L2-G3196	14.50
	Legend plate - blank for engraving Silver Yellow	LL2-A-6-000 LL2-I-6-000	7.27 6.27
	Legend plate - 0 - I, 90° Yellow	LL2-I-6-175	6.27
	Terminal cover - 3 or 4 pole For RA-40 For RE-40	RA-40-C4 RE-40-C4	16.62 12.17
	Dust Cover (not IP rated) FOR RE-40 1 or 2 switch wafers 3 or 4 switch wafers 5 or 6 switch wafers	RE-G3180 RE-G3181 RE-G3182	35.12 39.67 46.11

K

R-Line Rotary Cam Switches

① Switch handle can be field modified to be defeatable or non-defeatable.
② Handles LA7-S_ and L11-P_ require R-type Switch Handle Shaft Extension. See page L13.

Modular Shaft Extension system ①

Shaft Extension Modules are ideal for lengthening the shaft of an RA-40 switch up to 144mm (≈5.5"). These rugged polycarbonate modules are 24mm (≈15/16") long and snap on "piggyback" to one another without the use of tools. Strong center shafts interlock as each module is snapped together. The standard 44mm end shaft supplied with every RA-40 switch connects the last Extension Module to the Switch Handle Assembly. End shafts of 52 and 57mm are also available, making this modular system versatile, fast and economical. Shaft Extension Modules are supplied two per package.



Determining modular shaft extension components

- Determine mounting depth. This is the distance from the inside mounting surface of the enclosure to the **outside surface** of the enclosure cover. See diagram below for details.

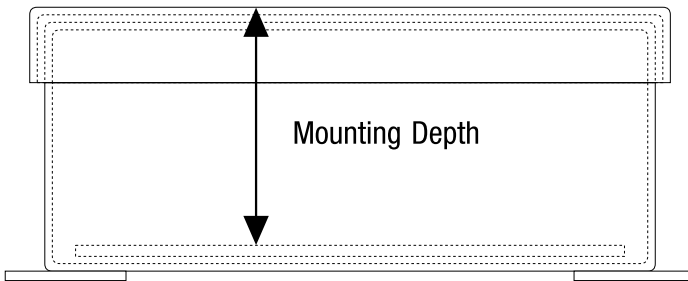





- If necessary, convert mounting depth inches to millimeters (inches x 25.4 = millimeters).
- In the Modular Shaft Extension Table to the right, find the correct range for your enclosure in the Mounting Depth column.

NOTE: Table is based on an RA-40 switch body with two wafers (3 or 4 pole). For a switch body with more or less wafers, add or subtract the following from overall Mounting Depth before referring to table:

RA-40 Switch Body - ±17.5mm per wafer

- Order the End Shaft and number of Extension Modules required for that mounting depth.

Modular Shaft Extension Components (RA40 Base Mount)

Component	Catalog Number	Price ea.
44mm End Shaft (supplied with RA-40 Switch Body Assembly) 	LA2-G2830	4.18
52mm End Shaft 	LA2-G3194	4.81
57mm End Shaft 	LA2-G3195	5.47
Extension Module (two per pkg - priced per pkg) 	LA2-G2853	8.70

Modular Shaft Extension Table

Number of Extension Modules	Required End Shaft	Mounting Depth (mm)
		Switch Body RA-40
0	44mm ②	98.5 - 104.5
0	52mm	100.5 - 114
0	57mm	109 - 119
1	44mm ②	122.5 - 128.5
1	52mm	124.5 - 138
1	57mm	133 - 143
2	44mm ②	146.5 - 152.5
2	52mm	148.5 - 162
2	57mm	157 - 167
3	44mm ②	170.5 - 176.5
3	52mm	172.5 - 186
3	57mm	181 - 191
4	44mm ②	194.5 - 200.5
4	52mm	196.5 - 210
4	57mm	205 - 215

① For Type R (4X) switch handle shaft extensions, see "Type R Switch Handle Extension" table on page K29.

② One 44mm End Shaft is supplied with all Switch Body Assemblies.

Metal shaft extension system ❶

Adjustable metal shaft extensions snap on securely to RA-40 switches via the same quick-connect design as shaft extension modules. Metal shafts are equipped with a door interlock and a padlock hasp for locking out the switch after the enclosure is opened (for outside lockout, select a Switch Handle with lockout capability).



Two standard lengths of these unique adjustable shafts are available. Metal shaft extensions mate with any of the standard Switch Handles. All necessary hardware is supplied with the shaft.

Determining metal shaft extension

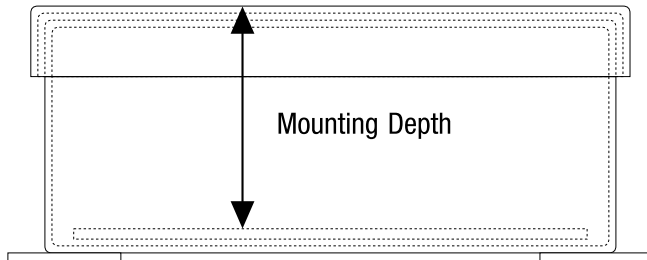

- Determine Mounting Depth. This is the distance from the inside mounting surface of the enclosure to the **outside surface** of the enclosure cover. See diagram below for details.



- If necessary convert Mounting Depth inches to millimeters (inches x 25.4 = millimeters).
- In the appropriate table to the right, find the correct range for your enclosure in the Mounting Depth column.
NOTE: Tables are based on an RA-40 switch body with two wafers (3 or 4 pole). For a switch body with more or less wafers, add or subtract the following from overall Mounting Depth before referring to table:
RA-40 Switch Body- ±17.5mm per wafer
- Order the Metal Shaft Extension required for that Mounting Depth and switch handle.

- ❶ Not for Type R (UL 4X) switch handles. Use Type R Switch Handle Extension table on this page.
- ❷ This dimension can be reduced by another 55mm by cutting the plastic sleeve and further cutting the metal shaft.
- ❸ Shaft included in package is designed for LA7-S_ and L11-P_ only. Not designed for use with previous L10-H_ handles.

Metal Shaft Extension Components (RA40 Base Mount)

Component	Catalog Number	Price each
Short Metal Shaft  Length: 10 . . . 235mm (4-21/64...9-1/4 in.)	LA2-G3393	34.20
Long Metal Shaft  Length: 230 . . . 350mm (9-3/64...13-51/64 in.)	LA2-G3394	44.38

Metal Shaft Extension Table

Metal Shaft Extension	Mounting Depth (mm)
	Switch Body RA-40
LA2-G3393	205 ⌀ - 336
LA2-G3394	325 - 451

Type R Switch Handle Shaft Extensions ❸

Only select shaft extension from this table if ordering the Type R (UL Type 4X) Switch Handle from the Accessories Section (page K27). Select shaft after figuring overall Mounting Depth.

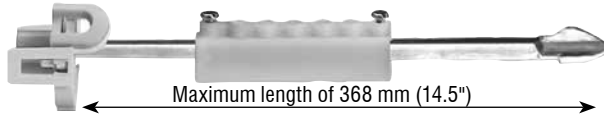
Type R Switch Handle Shaft Extension (typical)		
		
Mounting Depth (mm)	Catalog Number	
Switch Body RA-40		
119 - 143	LA7-S-67	See Page L13
142 - 166	LA7-S-90	
149 - 173	LA7-S-97	
167 - 191	LA7-S-115	
Adjustable R-type Switch Handle Shaft Extension (LA7-S1-P shown)		
 Maximum length of 368 mm (14.5")		
119 - 191	LA7-S1-P	See Page L13
Includes all parts except L11-S1 shaft, order separately	LA7-NS-P	

K
R-Line Rotary Cam Switches

Technical Information

					R-40
Rated Operating Voltage		UL/CSA	[V]	600	
		IEC/VDE/BS	[V]	690	
Rated Isolation Voltage					
Impulse			[V]	8	
Continuous				690	
Rated Thermal Current I_{th}		UL/CSA	[A]	40	
		IEC/VDE/BS	[A]	45	
Rated Thermal Current I_{the}		IEC/VDE/BS	[A]	45	
Rated Operating Current I_e					
AC-1/ AC21A	Switching resistive loads with slight overload	IEC947	690V	[A]	40
AC-22A	Switching mixed resistive and inductive loads at slight overload	IEC947	220-500V 600V	[A]	40
Short Circuit Current					
Rated conditional (note type & fuse size)			[kA]	5	
Maximum fuse rating of circuit, non-enclosed UL fuse type			[A]	40	Class J
Rated Operating Powers P_e ①					
AC-3	Squirrel-cage motors: starting and stopping of running motors	3Ø	230V	[kW]	7.5
		3 pole	400V	[kW]	18.5
			690V	[kW]	18.5
AC-4	Starting squirrel-cage motor starting, reversing, electric braking, inching	3Ø	230V	[kW]	5.5
		3 pole	400V	[kW]	7.5
			500V	[kW]	11
AC-23A	Periodic switching of motors or other highly inductive loads.	3Ø	230V	[kW]	11
		3 pole	400V	[kW]	11
			690V	[kW]	22
Rated Power					
Across the line AC motor starting		UL/CSA	120V	[HP]	5
DOL-rating		3Ø	240V	[HP]	10
		3 pole	480V	[HP]	25
			600V	[HP]	25
		1Ø	120V	[HP]	2
		2 pole	240V	[HP]	5
			480V	[HP]	10
			600V	[HP]	15
General use			600VAC	[A]	40
Rated Breaking Capacity		690V	[A]	196	
		Power factor		0.45	
DC-20 Switching					
Rated operating current I_e			[A]	40	
DC-1 Switching					
DC-21A Switching					
Rated operating current I_e			[A]	25	
		V max pole	[V]	60	
DC-23 Switching					
Rated power		24VDC	[kW]	0.3 (1)	
(the numbers in brackets indicate the number of poles that must be connected in series)		48VDC	[kW]	0.5 (2)	
		60VDC	[kW]	1 (2)	
		110VDC	[kW]	2 (3)	
		220VDC	[kW]	2.2 (5)	

				R-40
DC-13 Switching		24VDC	[A]	16
L/R = 40ms		48VDC	[A]	8
		60VDC	[A]	4.8
		110VDC	[A]	2
		220VDC	[A]	0.6
		380VDC	[A]	0.4
		500VDC	[A]	0.3
Maximum Wire Gauges				
Single/multi-core wire		(1 wire)	[mm ²]	10/6
			[AWG]	8/10
Single/multi-core wire		(2 wires)	[mm ²]	10/10
			[AWG]	8/10
Minimum Wire Gauges				
Single/multi-core wire		(1 wire)	[mm ²]	4/2.5
			[AWG]	12/14
Terminals				
Terminal Type				Screw M4
Protection Class				
Switch Handle Assembly				
LFS2-G(N)-6...		UL / IEC 529		Type 12 / IP66
LA7-SB/SY		UL		4/4X
LFS(C)2-...4(6, 8, 13)...		UL / IEC 529		Type 12 / IP66
Switch Body		IEC 529		IP20
Mechanical Life				[Millions of ops.] 1
Maximum Mechanical Operations (without derating)				[cycle/hr.] 1200
Maximum Electrical Operation (without derating)				[cycle/hr.] 120
Ambient Temperature				
Operation		Min...Max	[C°]	-25...+60
Storage only		Min...Max	[C°]	-40...+80
Maximum Altitude (without derating)				[m] ≤2000
				[ft.] ≤6561

Approvals



① Values approved by IMQ

K

R-Line Rotary Cam Switches

RE-40 Panel Mounting

Dimensions are in millimeters (inches). Dimensions not intended for manufacturing purposes.

Type G/N

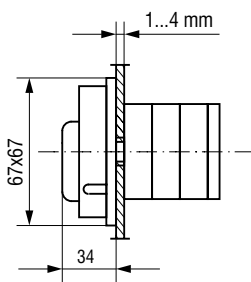

Type A

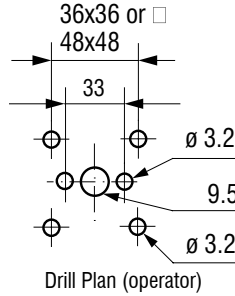
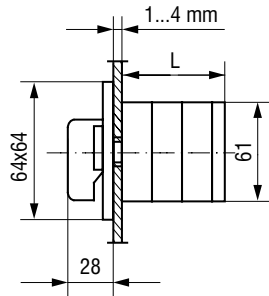

Screw Fixing (RE-40)

Type	"L" Dim (# of wafers)			
	1	2	3	4
RE-40	41	58.5	76	93.5

Type D (RC-40)

Type B (RC-40)

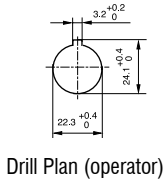
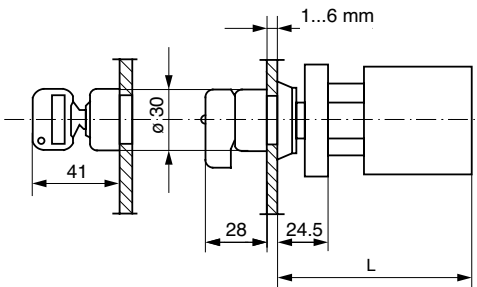

Central Fixing (RC-40)

Type	"L" Dim (# of wafers)							
	1	2	3	4	5	6	7	8
RC-40	86	103.5	121	138.5	156	173.5	191	208.5

RA-40 Base Mounting

Type G/N

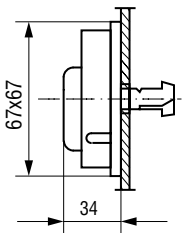

Type A

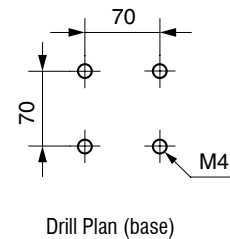
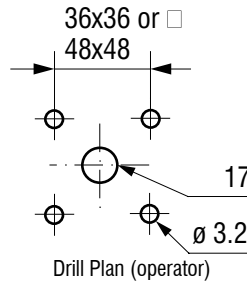
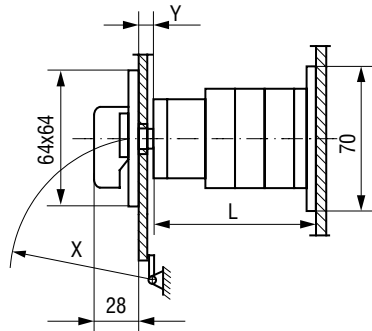

Type	"L" Dim (# of wafers)			
	1	2	3	4
RA-40	42.5	60	77.5	95

For LA7-SB/SY Handle Dimensions see page L22
 For L11-PB/PY Handle Dimensions see page L50

RA-40 Base Mount with LA2-G339_Metal Shaft Extension

Dimensions are in millimeters (inches). Dimensions not intended for manufacturing purposes.

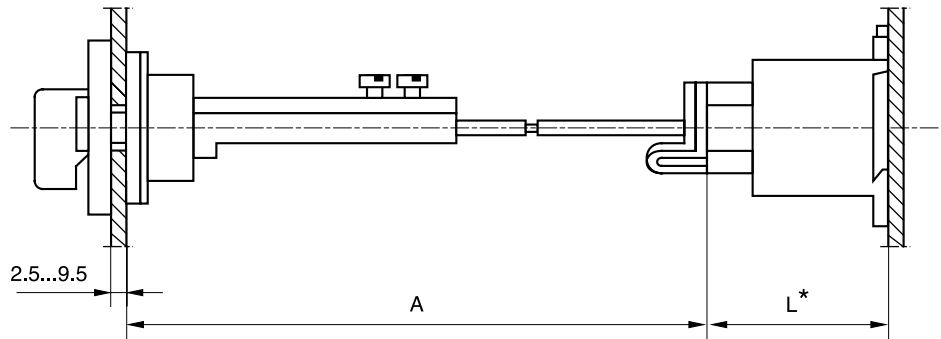

Type	"L" Dim (# of wafers)			
	1	2	3	4
RA-40	42.5	60	77.5	95

Type	"A" Dim
LA2-G3393	110 - 235
LA2-G3394	230 - 350

* Add 2.5mm for DIN rail 46277.

