

KT4 Manual Motor Starter

DISCONTINUED



Ideal for use as a manual starter

The KT4 is a manual motor starter that employs the features of power switching, thermal overload protection and control circuit signaling in one compact unit. This manual motor starter has the advantage of a high speed magnetic trip mechanism which limits the let-through current under short-circuit conditions. The KT4 can be supplied with field installable shunt trip or an under voltage trip unit which exceeds the capabilities of the classic manual motor starter. This manual motor starter is available in a variety of enclosures including general purpose, watertight and explosion proof (the most compact on the market today).

KT4 Reduces panel space and saves money in Group Motor Installations

The KT4 can eliminate the need for larger and more expensive fuse blocks and fused disconnects, or circuit breakers. The potential cost savings in group motor installations according NEC 430-53c can be as much as 35% over conventional methods of branch circuit protection. And, because so many features are combined into one small unit, panel space can be slashed by as much as 60%.

In addition, the KT4 line offers a wide application range from 0.1 to 16 FLA in installations up to 600V. For group motor applications, the KT4 series has a 250A group installation rating, with a withstand rating as high as 42 KAIC.



Excellent short circuit and thermal overload protection

In the event of a short-circuit, the contacts are opened by magnetic, non-adjusting tripping elements in times approaching 2/1000 of a second. This results in the extremely rapid build-up of an arc voltage which limits the current of the short-circuit to a very low level. Because of this superb current limiting capability the let-through current is significantly reduced and the potential for damage is limited.

Because each KT4 is individually calibrated at the factory for the smallest and largest current, very accurate thermal overload protection is also obtained. In addition, the KT4 is a Class 10 device ... it trips within 10 seconds under a locked rotor condition (6 x FLA). Every KT4 Manual Motor Starter is equipped with automatic ambient temperature compensation, which continually adjusts to surrounding temperatures. As a result, trip times remain constant and accurate.

Accessories add versatility

Whether in group motor installations or as a manual motor starter, numerous field installable accessories are available to enhance the KT4's performance:

- **Auxiliary Contact Blocks** – are available for internal or external mounting providing signal switching capability for control circuits.
- **Shunt trip and Undervoltage Release Modules** – provides the ability to remotely actuate the KT4 in emergency situations or continuously monitor the line voltage.
- **Enclosures** – are available in general protection (IP41), or watertight (IP55), complete with lockable accessories.
- **Compact Bus Bar System** – reduces the task of line side wiring in multiple motor starter installations which reduces the labor cost of installation.

F

KT4 Manual Motor Starters

KT4 Manual Motor Starter ❶

Maximum Horsepower ❶❷						O/L Relay Ampere Response ❸	Magnetic Response Current	Ordering Information ❶	
Single Ø ❷		Three Ø						Catalog Number	Price
115V	230V	200V	230V	460V	575V				
~	~	~	~	~	~	0.1 - 0.16	1.8	KT4-C2A-A16	200.05
~	~	~	~	~	~	0.16 - 0.25	2.8	KT4-C2A-A25	200.05
~	~	~	~	~	~	0.25 - 0.4	4.4	KT4-C2A-A40	200.05
~	~	~	~	~	~	0.4 - 0.63	6.9	KT4-C2A-A63	229.07
~	~	~	~	~	1/2	0.63 - 1.0	11	KT4-C2A-B10	229.07
~	1/10	~	~	1/2	3/4	1.0 - 1.6	18	KT4-C2A-B16	229.07
1/10	1/6	1/2	1/2	1	1-1/2	1.6 - 2.5	28	KT4-C2A-B25	229.07
1/8	1/3	3/4	3/4	2	3	2.5 - 4.0	44	KT4-C2A-B40	229.07
1/4	1/2	1	1-1/2	3	5	4.0 - 6.3	69	KT4-C2A-B63	229.07
1/2	1-1/2	2	3	5	7-1/2	6.3 - 10	110	KT4-C2A-C10	229.07
1	2	3	5	10	10	10 - 16	176	KT4-C2A-C16	262.24

F

KT4 Manual Motor Starters

Short Circuit Ratings ❸

Catalog Number	Manual Motor Starter / Group Installation Ratings		
	Short Circuit Rating (kA)		Maximum Branch Circuit Protection Rating ❸
	480V	600V	Amperes
KT4-C2A-A16	42	42	250
KT4-C2A-A25	42	42	250
KT4-C2A-A40	42	42	250
KT4-C2A-A63	42	42	250
KT4-C2A-B10	42	42	250
KT4-C2A-B16	42	42	250
KT4-C2A-B25	42	10	250
KT4-C2A-B40	18	5	250
KT4-C2A-B63	18	5	250
KT4-C2A-C10	10	5	250
KT4-C2A-C16	10	5	250

❶ Horsepower ratings shown are the maximum rating of the switching capacity of the main contactors. **The final selection of the manual starter depends on the actual motor full load amps and service factor.**

Example #1:

For a motor with a service factor of 1.15 or greater, use the motor nameplate full load amps and choose the motor starter with the appropriate current range.

Motor F.L.A. 4.2A
Service Factor 1.15

Select catalog number *KT4-C2A-A63 (Range 4.0-6.3 Amps)*

Example #2:

For a motor with a service factor less than 1.15, use the motor nameplate full load amps times 0.9 and choose the motor starter with the appropriate current range.

Motor F.L.A. 4.2A
Service Factor 1.0
Multiplier x 0.9
Effective Current = 3.78A

Select catalog number *KT4-C2A-A40 (Range 2.5-4.0 Amps)*

- ❷ Single phase horsepower ratings are based on wiring the 3 poles of the device in series.
- ❸ The KT4 motor circuit controller is approved for use in group installation according to NEC 430-53C. Reference Sprecher+Schuh UL file #E54612.
- ❹ The actual trip current is 120% of the dial setting.
- ❺ Although UL Testing of Manual Motor Starters allows for Group Installation with upstream Branch Circuit Protection maximum ratings as high as 250 amperes; it should be noted that NEC 2002 contains new restrictions under NEC 430-53D "Single Motor Taps". KT4 should be applied as outlined in NEC 430-53D-1 or 430-53-D-2 to be in compliance. KT4 does not qualify as "Tap Conductor Protection" as required under NEC 430-53-D-3. Please refer to the Application notes located at the end of the KT7 section for more details on compliance.



Accessories for KT4

Accessory	Description	Wiring Diagram	Catalog Number	Price
	Auxiliary Contact Block (NO) - mounts internally.		KT4-C-AEA10	22.80
	Auxiliary Contact Block (NO) - mounts internally, terminal markings appropriate when also using "PA" type auxiliary contact.		KT4-C-AEA210	22.80
	Auxiliary Contact Block (NC) - mounts internally.		KT4-C-AEA01	22.80
	Auxiliary Contact Block (NC) - mounts internally, terminal markings appropriate when also using "PA" type auxiliary contact.		KT4-C-AEA201	22.80
	Two pole Auxiliary Contact Block (NO/NC) - for side mounting. If using Compact Bus Bar System, choose bus bar with 54mm spacing		KT4-C-ASA11	42.49
	Two pole Auxiliary Contact Block (NO/NO) - for side mounting. If using Compact Bus Bar System, choose bus bar with 54mm spacing.		KT4-C-ASA20	42.49
	Two pole Auxiliary Contact Block (NC/NC) - for side mounting. If using Compact Bus Bar System, choose bus bar with 54mm spacing.		KT4-C-ASA02	42.49

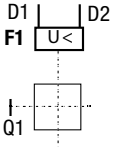

Accessory	Description	Catalog Number	Price
	Adaptor Plate Provides capability to base mount one KT4	KT4-C-N12	17.62
	Locking Fixture Padlocking attachment for one KT4-25. Locks in the OFF position only. Metal construction. Holds one to three padlocks with 6mm hasps.	KT4-C-M3	17.62

F
KT4 Manual Motor Starters

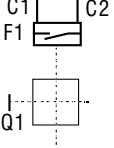
Accessories for KT4 (continued from previous page)





Accessory	Description	Wiring Diagram	AC Coil Voltage		Catalog Number	Price
			50 HZ	60 HZ		
	Undervoltage Release Module - mounts on right hand side, Prevents KT4 from operating unless voltage is present.		24V	~	KT4-C-UXK	100.54
			~	24V	KT4-C-UXJ	
			~	48V	KT4-C-UXX	
			110V	110V	KT4-C-UXKD	
			110V	120V	KT4-C-UXD	
			220...230V	240...260V	KT4-C-UXF	
			~	240...260V	KT4-C-UXA	
			240V	277V	KT4-C-UXT	
			400V	460V	KT4-C-UXN	
			415V	480V	KT4-C-UXB	
			500V	575V	KT4-C-UXM	
				Shunt Release Module - mounts on right hand side. Remotely trips the KT4 .		
~	24V	KT4-C-SXJ				
~	48V	KT4-C-SXX				
110V	110V	KT4-C-SXKD				
110V	120V	KT4-C-SXD				
220...230V	240...260V	KT4-C-SXF				
~	240...260V	KT4-C-SXA				
240V	277V	KT4-C-SXT				
400V	460V	KT4-C-SXN				
415V	480V	KT4-C-SXB				
500V	575V	KT4-C-SXM				



F KT4 Manual Motor Starters

Accessory	Description	Voltage / Rated Current	Catalog Number	Price
	Connecting Module  - Provides a solid "wireless" connection between a KT4 Motor Circuit Controller and a CA7 contactor. Connects CA7-9...23	20A	KT4-C-PNC23	18.66

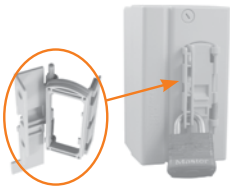
 cULus Approved (File E33916).



Accessories for KT4 (continued from previous page)

Accessory	Description	Enclosure Rating	Catalog No. ❶	Price
 KT4-C-EA55	Enclosures for Surface Mounting - Includes ground and neutral terminals.	General Purpose (IP41)	KT4-C-EA41	75.67
		Watertight (IP55)	KT4-C-EA55	134.75
 KT4-C-EE55	Enclosure for Flush Mounting - includes protective earth and neutral wire terminals.	General Purpose (IP41)	KT4-C-EE41	42.49
		Watertight (IP55)	KT4-C-EE55	52.86
	Enclosure Locking Fixture - Holds one to three padlocks with 6mm hasps.	For use with KT4-C-EA41 and KT4-C-EA55 enclosures	KT4-C-M3E	17.62
	Enclosure Membrane - Replacement membrane. Includes 4 mounting screws (membrane only, does not include mounting frame).	For replacement on KT4-C-EA55 or -EE55 or to upgrade KT4-C-EA41 or -EE41 enclosures	KT4-C-N55	8.81

Accessory	Description	Kit Catalog No.	Kit Price	For Use With	Assembled Cat No. ❶	Price
 KT4-C-MT-EA55	Emergency Stop Kit Twist-To-Release	KT4-C-MT	47.68	KT4-C-EA41	KT4-C-MT-EA41	135.78
				KT4-C-EE41	KT4-C-MT-EE41	103.65
				KT4-C-EA55	KT4-C-MT-EA55	199.01
				KT4-C-EE55	KT4-C-MT-EE55	111.95
 KT4-C-MK-EA55	Emergency Stop Kit Key Release	KT4-C-MK	76.70	KT4-C-EA41	KT4-C-MK-EA41	164.81
				KT4-C-EE41	KT4-C-MK-EE41	132.68
				KT4-C-EA55	KT4-C-MK-EA55	229.07
				KT4-C-EE55	KT4-C-MK-EE55	140.96

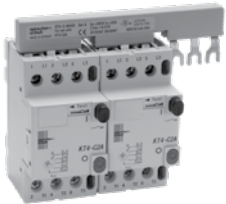
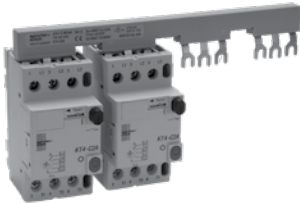

❶ KT4 Manual Motor Starter Not Included. Consult a Sprecher + Schuh representative for an assembly including a KT4.

Compact Bus Bar System for KT4

Accessory	Description	Catalog Number	Price
	<p>Compact Bus Bar - 45mm spacing - Bus bar with 45mm spacing accepts KT4's with <i>or without</i> internally mounted auxiliary or trip signal contact. Rated to 65A (UL)/63A (IEC).</p> <p>Connects two KT4's Connects three KT4's Connects four KT4's Connects five KT4's</p>	KT4-C-W452	41.46
		KT4-C-W453	47.68
		KT4-C-W454	53.89
		KT4-C-W455	59.08
	<p>Compact Bus Bar - 54mm spacing - Bus bar with 54mm spacing accepts KT4's with side mounted auxiliary contact (type PA-11). Rated to 65A (UL)/63A (IEC).</p> <p>Connects two KT4's Connects three KT4's Connects four KT4's Connects five KT4's</p>	KT4-C-W542	41.46
		KT4-C-W543	47.68
		KT4-C-W544	53.89
		KT4-C-W545	59.08
	<p>Supply Block - Provides connection from bus bar to power.</p>	KT4-C-WT	38.35
	<p>Blank Space Cover - Covers bus bar connections where no KT4 is mounted.</p>	KT4-C-WS	6.22

F
KT4 Manual Motor Starters

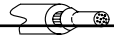
Technical Information

Standards Approvals	KT4... UL 508; CSA22.2; EN/IEC 60947-1/-2/-4/-5-1/ UL, CSA, CE, SEV, Germ. Lloyd, CEBEC, PTB, DEMKO, SEMKO, SETI, NEMKO, Bureau Veritas, Lloyd's Register of Shipping, Maritime Register of Shipping, RINA, KEMA	
Approvals / Markings	CE, cULus Listed	
Rated Insulation Voltage		
IEC, SEV, VDE0660 [V]		690
UL, CSA [V]		600
Rated Impulse Withstand Voltage		
Main circuits		6 kV
Auxiliary circuits		6 kV
Rated Frequency [Hz]		40...60
Rated Operating Current [A]		0.1...16 (11 ranges)
Life		
Mechanical [operations]		100,000
Electrical [operations]		50,000
Switching Frequency		Max. 30 operating cycles/hour
Ambient Temperature		
Storage		-25°C to +80°C
Operation		-25°C to +60°C
Resistance to climatic change		
Humid heat		40°C, 92%, 56 days
Alternating climatic conditions		23°C, 83%/40°C, 93%, 56 cycles
Degree of Protection		IP20 (when wired)
Impact Resistance (shock)		50g, 11ms
Vibration Strength		
Frequency Range		10...150Hz
In all directions		>7.5g
Overload Protection		
Tripping Time		Class 10
Phase failure protection		See time/current curve
Temperature Compensation		-20°C... +60°C (70°C=15% current reduction of upper rated current)
Magnetic Response		11 x I _e max. (fixed setting) (I _e max. = max value of the setting range)
Total Power dissipation		
Manual motor starter at rated load [W]		7
Terminal Connections		
Type of terminals		
Screwdriver		Position  Blade No. 3
	1. conductor	1 to 4 mm ² / 16 to 12 AWG
	2. conductor	1 to 4 mm ² / 16 to 12 AWG
	1. conductor	1 to 6 mm ² / 16 to 12 AWG
	2. conductor	1 to 6 mm ² / 16 to 12 AWG
	1. conductor	1.5 to 6 mm ² / 16 to 12 AWG
	2. conductor	1.5 to 6 mm ² / 16 to 12 AWG
Tightening torque		2 to 2.5 Nm / 18 to 22 lb-in

Mounting Position - KT4

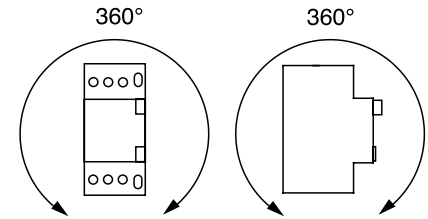















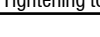

Weights

Description	Catalog Number	Weight
Manual Motor Starter	KT4-C2A...	290 g
Auxiliary Contact Blocks for Flush Mounting	KT4-C-AEA	12 g
Auxiliary Contact Blocks for Left-side Mounting	KT4-C-ASA	35 g
Undervoltage Release	KT4-C-UX	104 g
Shunt Release	KT4-C-SX	100 g
Bus Bar Feeder Terminal	KT4-C-WT	36 g
Compact Bus Bar	KT4-C-W452	42 g
	KT4-C-W453	69 g
	KT4-C-W454	94 g
	KT4-C-W455	119 g
	KT4-C-W542	45 g
	KT4-C-W543	76 g
	KT4-C-W545	104 g
	KT4-C-W545	135 g
Blank Space Cover	KT4-C-WS	3.3 g
Emergency-Stop Push Button	KT4-C-MT	g
	KT4-C-MK	g
Enclosure for Surface Mounting	KT4-C-EA41	250 g
Enclosure for Flush Mounting	KT4-C-EA55	258 g
Button Membrane	KT4-C-EE41	126 g
	KT4-C-EE55	134 g
Indicator Light	KT4-L...	10 g
Hut (DIN) rail Adapter	KT4-C-N12	16 g
	KT4-C-M3E	19 g
Locking Arrangement	KT4-C-M3	11 g

F
KT4 Manual Motor Starters

Technical Information

Specifications of Accessories	KT4-C-AEA... Auxiliary Contact Block for Flush Mounting				KT4-C-ASA... Auxiliary Contact Block for Left-side Mounting			
Rated Thermal Current I_{th} at 40°C ambient temperature [A]	6				10			
at 60°C ambient temperature [A]	4				6			
Contact Class Coordination According to NEMA (UL/CSA Standards) [AC] [DC]	B 600 Standard Pilot Duty R 300 Light Pilot Duty				B 600 Standard Pilot Duty R 300 Light Pilot Duty			
Back-Up Fuses gG, gL [A]	16				16			
Rated Supply current [V]	230/240	400/415	500	690	230/240	400/415	500	690
AC-15 [A]	2	1	0.8	0.5	2	1	0.8	0.5
DC-13 [V]	24	48	110	220	24	48	110	220
[A]	2	0.6	0.2	0.1	2	0.6	0.2	0.1
Terminal Parts Type of terminals								
Screwdriver	Poizdrive No. 2 / Blade No. 3							
 1. conductor	0.75 to 2.5 mm ² / 18 to 14 AWG				0.75 to 2.5 mm ² / 18 to 14 AWG			
 2. conductor	0.75 to 2.5 mm ² / 18 to 14 AWG				0.75 to 2.5 mm ² / 18 to 14 AWG			
 1. conductor	0.75 to 4 mm ² / 18 to 14 AWG				0.75 to 4 mm ² / 18 to 14 AWG			
 2. conductor	0.75 to 4 mm ² / 18 to 14 AWG				0.75 to 4 mm ² / 18 to 14 AWG			
 1. conductor	0.75 to 4 mm ² / 18 to 14 AWG				0.75 to 4 mm ² / 18 to 14 AWG			
 2. conductor	0.75 to 4 mm ² / 18 to 14 AWG				0.75 to 4 mm ² / 18 to 14 AWG			
Tightening torque	1 to 1.5 Nm / 9 to 13 lb-in				1 to 1.5 Nm / 9 to 13 lb-in			

	KT4-C-UX... Undervoltage Release Unit for Right-side Mounting	KT4-C-SX... Shunt Release for Right-side Mounting	KT4-C-WT Supply Block
Actuating Voltage Pull-in	0.8 to 1.1 x U_s	0.7 to 1.1 x U_s	
Drop-out	0.7 to 0.35 x U_s	~	
Rated Control Voltage min.	12V 50 Hz, 14V 60 Hz	12V 50 Hz, 14V 60 Hz	
max.	600V 50 Hz	600V 50 Hz	
On-Time	100 %	100%	
Coil Rating Pull-in	8.5 VA, 6 W	8.5 VA, 6 W	
Hold	3 VA, 1.2 W	3 VA, 1.2 W	
Terminal Parts Type of terminals			
Screwdriver	Poizdrive No. 2/Blade No. 3	Poizdrive No. 2/Blade No. 3	Poizdrive No. 2/Blade No. 3
 1. conductor	0.75 to 2.5 mm ² / 18 to 14 AWG	0.75 to 2.5 mm ² / 18 to 14 AWG	4 to 16 mm ² / 14 to 6 AWG
 2. conductor	0.75 to 2.5 mm ² / 18 to 14 AWG	0.75 to 2.5 mm ² / 18 to 14 AWG	4 to 16 mm ² / 14 to 6 AWG
 1. conductor	0.75 to 4 mm ² / 18 to 14 AWG	0.75 to 4 mm ² / 18 to 14 AWG	4 to 16 mm ² / 14 to 6 AWG
 2. conductor	0.75 to 4 mm ² / 18 to 14 AWG	0.75 to 4 mm ² / 18 to 14 AWG	4 to 16 mm ² / 14 to 6 AWG
 1. conductor	0.75 to 4 mm ² / 18 to 14 AWG	0.75 to 4 mm ² / 18 to 14 AWG	4 to 16 mm ² / 14 to 6 AWG
 2. conductor	0.75 to 4 mm ² / 18 to 14 AWG	0.75 to 4 mm ² / 18 to 14 AWG	4 to 16 mm ² / 14 to 6 AWG
Tightening torque	1 to 1.5 Nm / 9 to 13 lb-in	1 to 1.5 Nm / 9 to 13 lb-in	4 Nm / 36 lb-in

	KT4-C-W45... Compact Bus Bar	KT4-C-W54... Compact Bus Bar
Rated Insulation Voltage U_i [V]	690	690
Rated Thermal Current I_{th} [A]	63	63

	KT4-C-EA41 / -EE41 Enclosure	KT4-C-EA55 / -EE55 Enclosure	KT4-C-L... Indicator Light
IP Protection	IP41	IP55 (with seal and protective membrane)	IP54
Ambient Temperature [°C]	- 25...+ 40	- 25...+ 40	~
Rated Operating Voltage [V]	~	~	120, 240, 415, 480

IEC Performance Data (KT4-C2A)

		-A16	-A25	-A40	-A63	-B10	-B16	-B25	-B40	-B63	-C10	-C16
Switching of standard three phase motors												
AC-2, AC-3												
230/240V	[kW]	~	~	~	0.06/0.09	0.12	0.18/0.25	0.37	0.55/0.75	1.1/1.5	2.2	3.0/4.0
400/415V	[kW]	0.02	0.06	0.09	0.18/0.25	0.25	0.37/0.55	.75	1.1/1.5	2.2	3.0/4.0	5.5/7.5
500V	[kW]	~	~	~	0.18	0.25/0.37	0.55/0.75	1.1	1.5/2.2	2.5/3.0	4.0/6.3	7.5/10
690V	[kW]	~	~	~	0.25	0.37/0.55	0.75/1.1	1.8	2.2/3.0	~	~	~
Back-up fuses												
gG, aM, only if I _{cc} > I _{cu}												
230/240V	[A]	No Fuses Required						~	~	~	~	50
400/415V	[A]							~	~	~	63	50
500V	[A]							~	~	63	50	50
690V	[A]							25	35	~	~	~
Ultimate short-circuit breaking capacity I_{cu}												
230/240V	[kA]	65	65	65	65	65	65	50	50	50	50	3
400/415V	[kA]	65	65	65	65	65	65	50	10	10	8	6
500V	[kA]	50	50	50	50	50	50	50	3	10	4.5	4.5
690V	[kA]	50	50	50	50	50	50	4.5	2	~	~	~

CSA Performance Data (KT4-C2A)

		-A16	-A25	-A40	-A63	-B10	-B16	-B25	-B40	-B63	-C10	-C16
Maximum short-circuit current												
480V	[kA]	42	42	42	42	42	42	42	18	18	10	5
600V	[kA]	42	42	42	42	42	42	10	5	5	5	5
Motor load												
1-phase												
115V	[HP]	~	~	~	~	~	~	1/10	1/8	1/4	1/2	1
230V	[HP]	~	~	~	~	~	1/10	1/6	1/3	3/4	1 1/2	3
3-phase												
200V	[HP]	~	~	~	~	~	~	1/2	3/4	1 1/2	2	3
230V	[HP]	~	~	~	~	~	~	3/4	1	2	3	5
460V	[HP]	~	~	~	~	1/2	1	1 1/2	3	5	7 1/2	10
575V	[HP]	~	~	~	~	3/4	1	2	3	5	10	15

Auxiliary Contact & Trip Indicator Contact Development ①

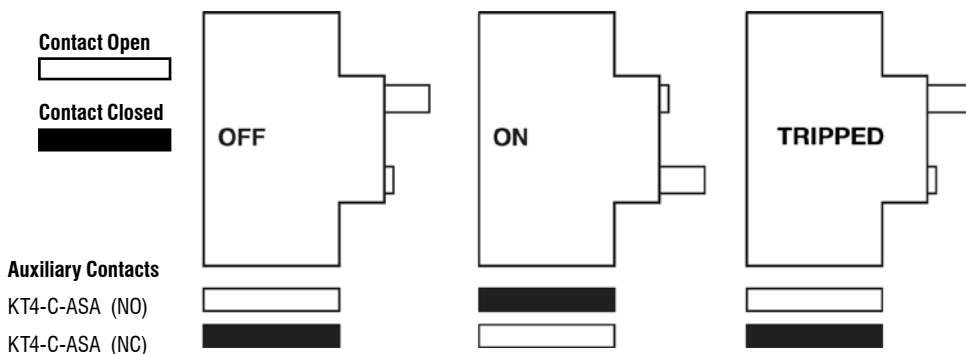

① KT4 leaves the factory in the Auto Reset mode. This means the Off and Trip positions are the same. If a true trip position is required, consult your Sprecher + Schuh representative.

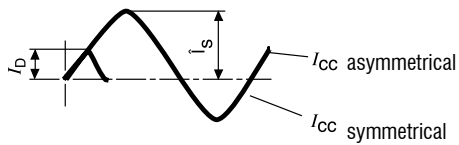

The KT4-C2A manual motor starter limits short-circuit current I_{cc} (prospective short-circuit current). I_D is the maximum cut-off current (highest instantaneous value of the limited short-circuit current). This value is indicated in the following diagram as a function of the system short-circuit current.

Correspondingly the maximum forward $\int^2 dt$ energy is limited. This value is indicated in the following diagram as a function of the system short-circuited current.

KT4-C2A
Max. Let-Through (cut-off) Current, $U_e = 400...415V$

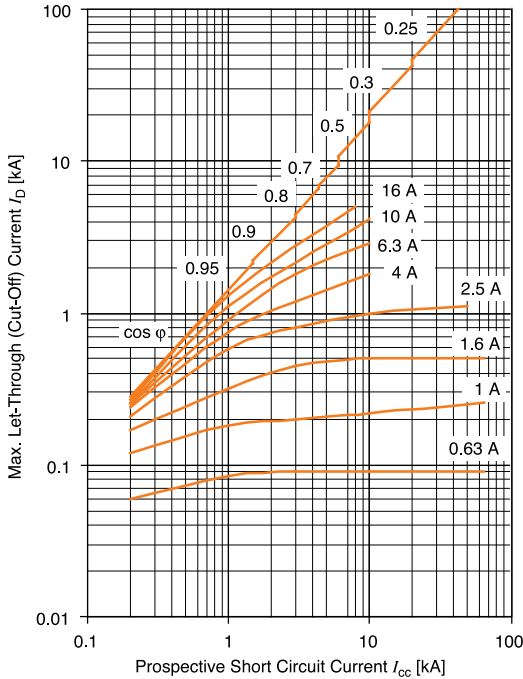

KT4-C2A
Max. Let-Through Energy, $U_e = 400...415V$

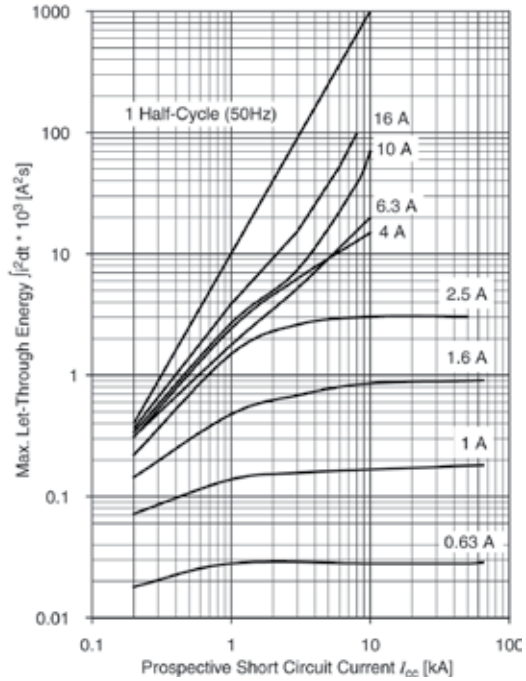

F KT4 Manual Motor Starters

KT4-C2A
Time / current characteristics

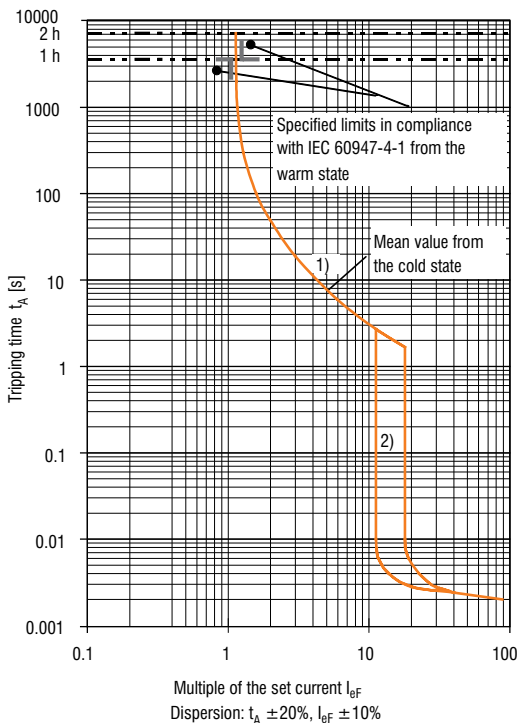

1) Operating Current of Thermal Releases:

The adjustable inverse bimetal trip reliability protects motors against overloads. The curve shows the mean operating current at an ambient temperature of 20°C starting from cold.

In equipment at operating temperature, release time is less than or equal to release time from the cold state.

2) Operating Current of Magnetic Releases:

Electromagnetic instantaneous releases react at a fixed tripping current.

At the upper thermal release setting, this tripping current is 11 times the set current.

Current To Be Set:

Thermal releases meet the requirements for a thermal release of a starter in accordance with IEC 60947-4-1 f. If a different value is specified (such as reduced I_e in motors with an ambient temperature higher than 40°C or a site altitude >2000 m above sea level), the rated operating current I_e must be adjusted.

Single, Two and Three Phase Connection Diagram

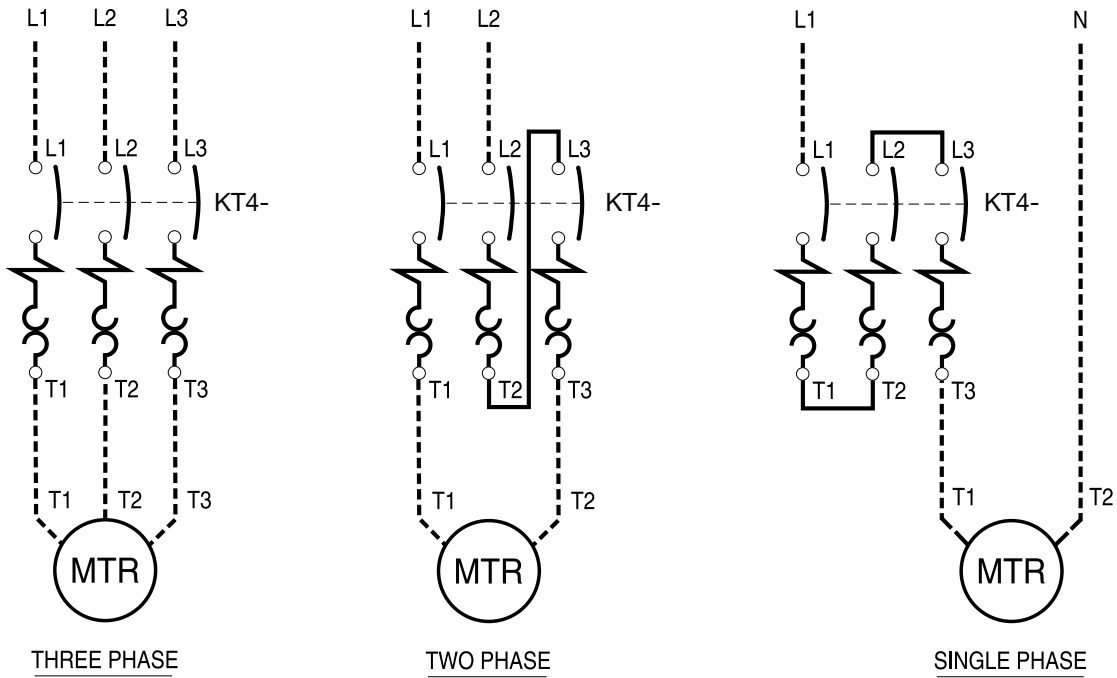

F
KT4 Manual Motor Starters

Dimensions are in millimeters (except where noted). Dimensions not intended for manufacturing purposes.

KT4 Motor Circuit Controller

KT4 with Compact Bus Bar

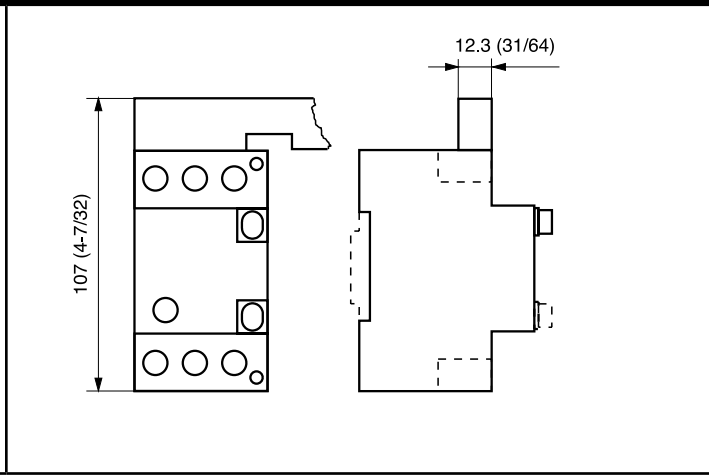
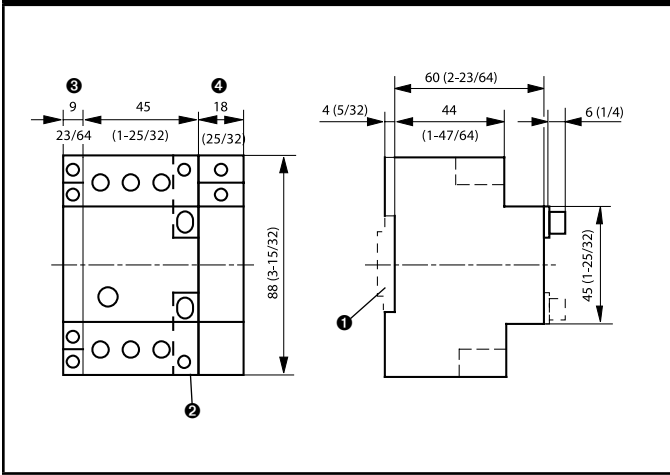

- ❶ DIN rail (EN 50022-35)
- ❷ KT4 w/KT4-C-AEA (no dimension change)
- ❸ KT4-C-ASA
- ❹ KT4-C-SXB or KT4-C-UXA

KT4-C-WT

KT4-C2A with KT4-C-WT

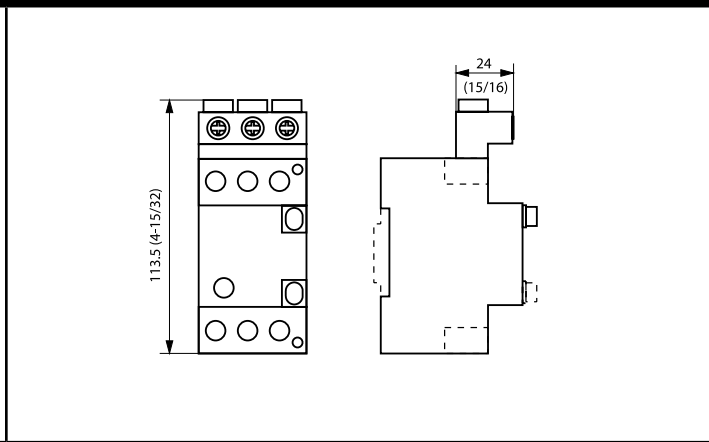
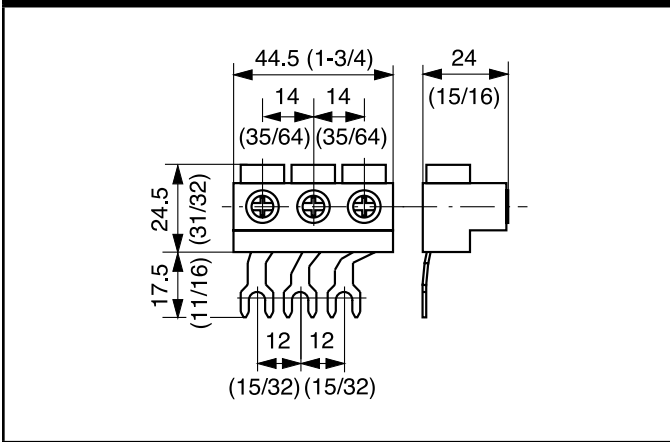

KT4-C-N12

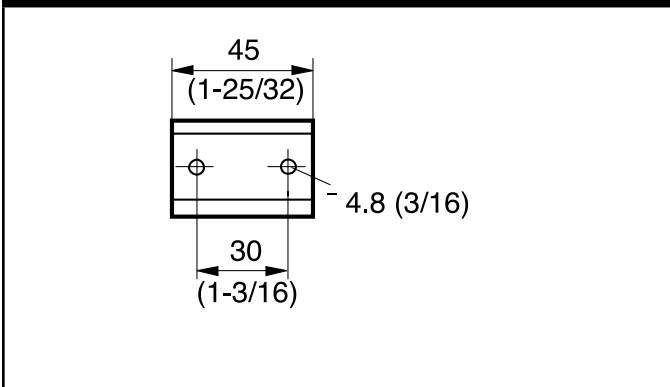

F KT4 Manual Motor Starters

KT4-C-EA55 Enclosure

Dimensions are in millimeters (except where noted). Dimensions not intended for manufacturing purposes.

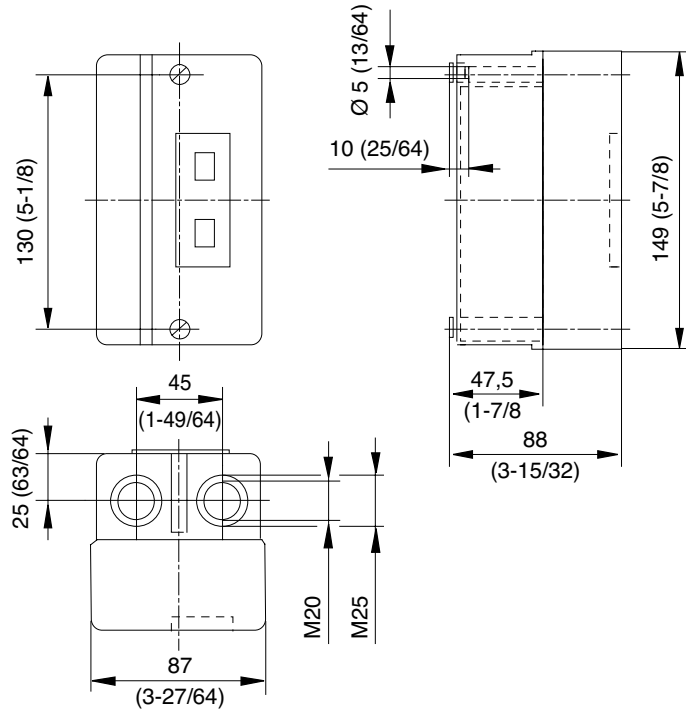

KT4-C-EE41 Enclosure

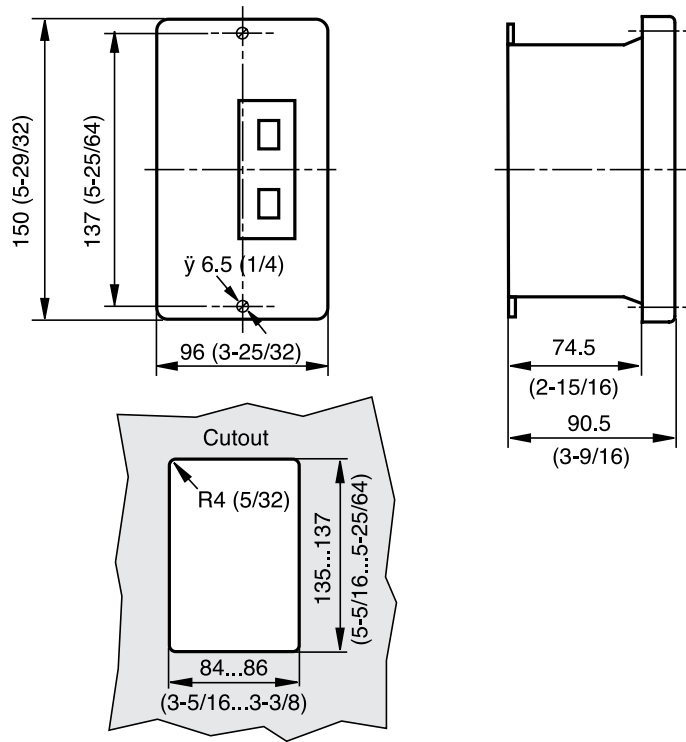

F
KT4 Manual Motor Starters

