

Series KT9 Motor Circuit Controllers

Versatile, convenient
and space saving...
for a variety of
applications

Sprecher + Schuh's KT9 Series of Motor Protection Circuit Breakers (MPCBs) or Motor Protective Switching Devices (MPSDs) are UL Listed as Manual, Self-Protected Combination Motor Controllers (Type E) and Manual Motor Controllers (with approvals for Suitable as Motor Disconnect and Suitable for use in Group Installation).

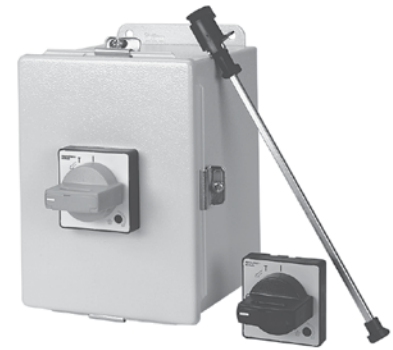

KT9s meet UL requirements for Type E manual motor controllers and "at-motor disconnects"

When UL/CSA Listed as Manual, Self-Protected Combination Motor Controllers, the KT9 Motor Protection Circuit Breakers provide all of the necessary NEC/CEC requirements for the protection and control of individual Motor Branch Circuits without additional branch circuit protective devices. According to UL 60947-4-1, CSA C22.2 No.60947-4-1, these devices may provide the following control and protection functions.

only one Branch Circuit Protective Device (BCPD) for the "Group". Series KT9 devices are also UL Listed for Tap Conductor protection in group installations, which helps reduce conductor sizing. According to UL 60947-4-1, CSA C22.2 No.60947-4-1, these devices these devices certified for group motor installation may provide the following control and protection functions.



- Disconnect for motor branch circuit
- Short-circuit Protection (magnetic protection)
- Overload protection (thermal protection)
- Manual switching (motor control means)

- Disconnect for motor branch circuit
- Overload protection (thermal protection)
- Manual switching (motor control means)

Group motor installations eliminate the need for individual branch short-circuit protective devices for each motor circuit, reducing panel space, installation and wiring time, and costs. There is

See our online white paper

Methods of Applying

KT9

Motor Circuit Controllers

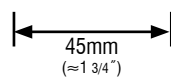

0.10...32A
Standard Interrupting Capacity

KTA9-32S

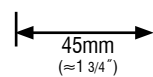

0.40...40A
High Interrupting Capacity

KTA/C9-40H

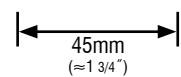

0.16...40A
High Interrupting Capacity

KT9-40H

Series KT9 devices meet requirement of Motor Protective Switching Devices (MPSD) according to IEC 60947-4-1 and Circuit Breaker according to IEC 60947-2 standard for application outside of North America. These devices provide the following functions.

- Disconnect for motor branch circuit
- Short-circuit Protection (magnetic protection)
- Overload protection (thermal protection)
- Manual switching (motor control means)

KT9 devices provide Trip Class 10 overload protection and phase loss sensitivity protection. These are suitable for single- and three- phase applications. Cat. No. KTV9 devices can also be applied at the output of a variable frequency drive (VFD) in multi-motor applications.

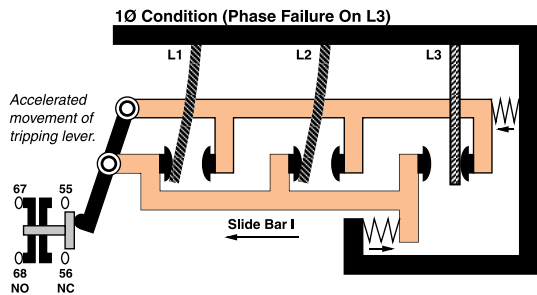

All KT9 Motor Circuit Controllers offer accelerated tripping under single phase conditions

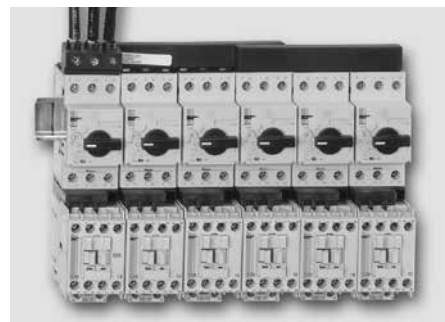
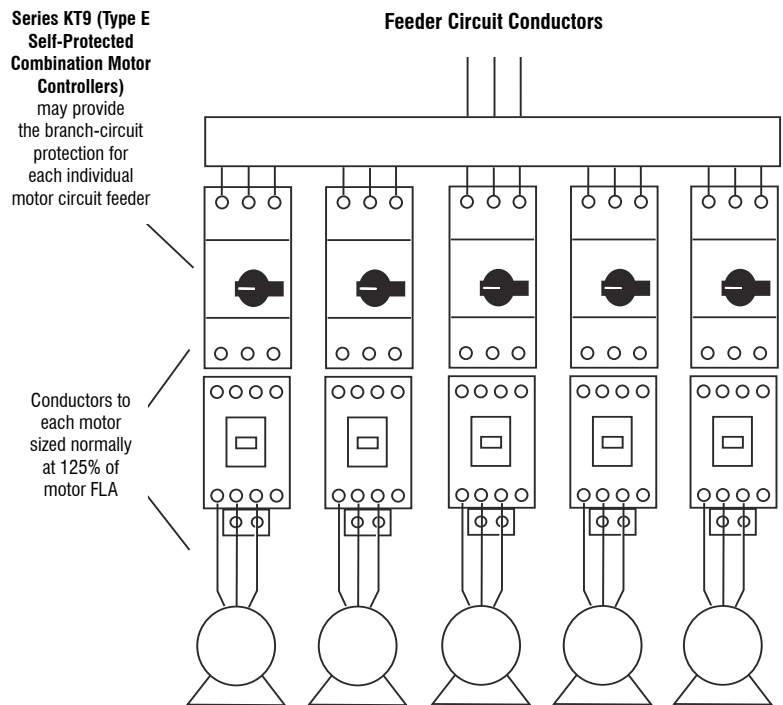
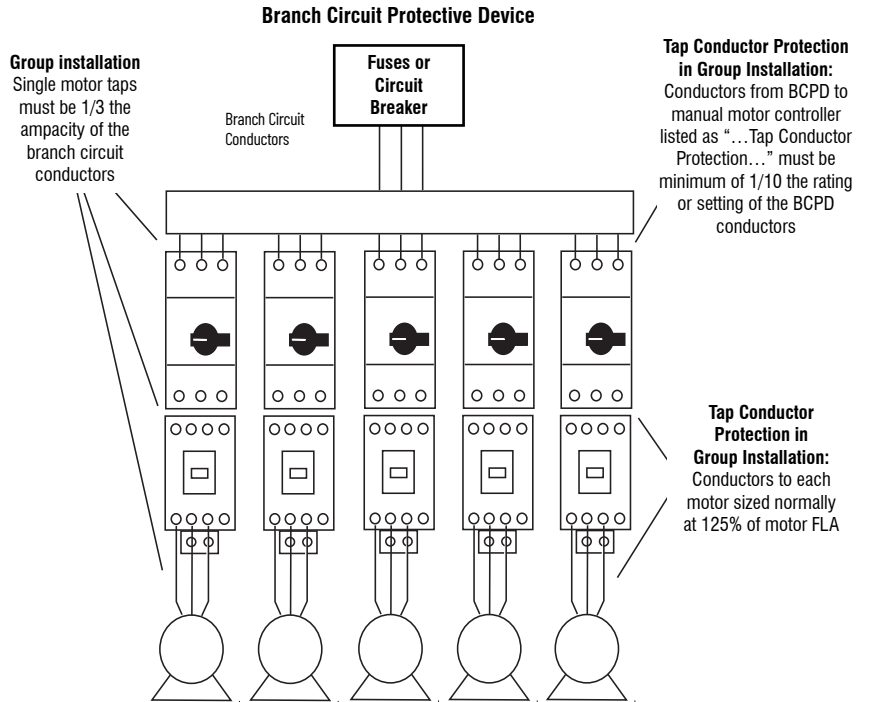

Using KT9s in Multi-Motor Starter applications can replace classic Branch Circuit Protection Devices and reduce panel space up to 60%

KTA9 Base Unit

Typical Three Phase [HP]				Current Adjustment Range [A]	Magnetic Release Response Current [A]	Catalog Number
200V	230V	460V	575V			
KTA9-32S Adjustable Thermal/Fixed Magnetic (14 x I_n)						
~	~	~	~	0.10...0.16	2.2	KTA9-32S-0.16A
~	~	~	~	0.16...0.25	3.5	KTA9-32S-0.25A
~	~	~	~	0.25...0.40	5.6	KTA9-32S-0.4A
~	~	~	~	0.40...0.63	8.8	KTA9-32S-0.63A
~	~	1/2	1/2	0.63...1.0	14	KTA9-32S-1.0A
~	~	3/4	~	1.0...1.6	22	KTA9-32S-1.6A
1/2	1/2	1	1-1/2	1.6...2.5	35	KTA9-32S-2.5A
3/4	3/4	2	3	2.5...4.0	56	KTA9-32S-4.0A
1	1-1/2	3	5	4.0...6.3	88	KTA9-32S-6.3A
2	2	5	7-1/2	6.3...10	140	KTA9-32S-10A
3	5	10	10	10...16	224	KTA9-32S-16A
5	5	10	15	14.5...20	280	KTA9-32S-20A
5	7-1/2	15	20	18...25	350	KTA9-32S-25A
7-1/2	10	20	25	23...29	406	KTA9-32S-29A
7-1/2	10	20	30	26.5...32	448	KTA9-32S-32A
KTA9-40H Adjustable Thermal/Fixed Magnetic (14 x I_n)						
~	~	~	~	0.40...0.63	8.8	KTA9-40H-0.63A
~	~	1/2	1/2	0.62...1.0	14	KTA9-40H-1.0A
~	~	3/4	~	1.0...1.6	22	KTA9-40H-1.6A
1/2	1/2	1	1-1/2	1.6...2.5	35	KTA9-40H-2.5A
3/4	3/4	2	3	2.5...4.0	56	KTA9-40H-4.0A
1	1-1/2	3	5	4.0...6.3	88	KTA9-40H-6.3A
2	2	5	7-1/2	6.3...10	140	KTA9-40H-10A
3	5	10	10	10...16	224	KTA9-40H-16A
5	5	10	15	14.5...20	280	KTA9-40H-20A
5	7-1/2	15	20	18...25	350	KTA9-40H-25A
7-1/2	10	20	25	23...29	406	KTA9-40H-29A
7-1/2	10	20	30	26.5...32	448	KTA9-40H-32A
10	10	25	30	30...36	432	KTA9-40H-36A
10	10	30	30	34...40	480	KTA9-40H-40A
KTA7-45H Adjustable Thermal/Fixed Magnetic (13 x I_n)						
2	3	5	7-1/2	6.3...10	130	KTA7-45H-10A
3	5	10	10	10...16	208	KTA7-45H-16A
5	5	10	15	14.5...20	260	KTA7-45H-20A
7-1/2	7-1/2	15	20	18...25	325	KTA7-45H-25A
7-1/2	10	20	30	23...32	416	KTA7-45H-32A
10	15	30	40	32...45	585	KTA7-45H-45A



Catalog Number KTA9-32S



Catalog Number KTA9-40H



Catalog Number KTA7-45H

F KTA9 Motor Circuit Controllers

Horsepower ratings shown in the table are for reference only. The final selection of the controller depends on the actual motor full load current and service factor.

- For motor with service factor less than 1.15. Use motor nameplate full load current times 0.9 and choose the motor starter with the appropriate current range. Example: Motor F.L.C. = 4.2A; S.F. = 1.0. - 4.2A x 0.9 = 3.78A. Select Catalog Number KTA9-32S-4.0A.

KTA9 UL Ratings Application Chart

Device	Manual Controller for Group Installation ❶		Manual Controller as Motor Disconnect ❷		Suitable for Tap Conductor Protection		Self-Protected Type E Manual Combination Controller ❸❹		
	Max. Fuse or Circuit Breaker	Max. Short Circuit Current [kA]		Max. Short Circuit Current [kA]		Max. Short Circuit Current [kA]		Max. Short Circuit Current [kA]	
		480V	600V	480V	600V	480Y/277V	600Y/347V	480Y/277V	600Y/347V
KTA9-32S — Standard Interrupting Capacity									
KTA9-32S-0.16A	450	65	50	65	50	65	50	65	50
KTA9-32S-0.25A	450	65	50	65	50	65	50	65	50
KTA9-32S-0.4A	450	65	50	65	50	65	50	65	50
KTA9-32S-0.63A	450	65	50	65	50	65	50	65	50
KTA9-32S-1.0A	450	65	50	65	50	65	50	65	50
KTA9-32S-1.6A	450	65	50	65	50	65	50	65	50
KTA9-32S-2.5A	450	65	30	65	30	65	30	65	30
KTA9-32S-4.0A	450	65	30	65	30	65	30	65	30
KTA9-32S-6.3A	450	65	30	65	30	65	~	65	~
KTA9-32S-10A	450	65	30	65	30	65	~	65	~
KTA9-32S-16A	450	30	30	30	30	30	~	30	~
KTA9-32S-20A	450	30	30	30	10	~	~	~	~
KTA9-32S-25A	450	30	18	30	5	~	~	~	~
KTA9-32S-29A	450	30	10	10	~	~	~	~	~
KTA9-32S-32A	450	30	10	10	~	~	~	~	~
KTA9-40H — High Interrupting Capacity									
KTA9-40H-0.63A	450	65	50	65	50	65	50	65	50
KTA9-40H-1.0A	450	65	50	65	50	65	50	65	50
KTA9-40H-1.6A	450	65	50	65	50	65	50	65	50
KTA9-40H-2.5A	450	65	30	65	30	65	30	65	30
KTA9-40H-4.0A	450	65	30	65	30	65	30	65	30
KTA9-40H-6.3A	450	65	30	65	30	65	30	65	30
KTA9-40H-10A	450	65	30	65	30	65	30	65	30
KTA9-40H-16A	450	30	30	65	30	65	30	65	30
KTA9-40H-20A	450	30	30	65	30	65	~	65	~
KTA9-40H-25A	450	50	30	50	30	50	~	50	~
KTA9-40H-29A	450	50	30	50	30	50	~	50	~
KTA9-40H-32A	450	50	30	30	18	30	~	30	~
KTA9-40H-36A	450	30	30	30	18	30	~	30	~
KTA9-40H-40A	450	30	30	30	18	30	~	30	~
KTA7-45H — High Interrupting Capacity									
KTA7-45H-10A	600	65	30	65	30	65	30	65	30
KTA7-45H-16A	600	65	30	65	30	65	30	65	30
KTA7-45H-20A	600	65	30	65	30	65	30	65	30
KTA7-45H-25A	600	65	30	65	30	65	30	65	30
KTA7-45H-32A	600	65	30	65	30	65	30	65	30
KTA7-45H-45A	600	65	18	65	18	65	~	65	~

- ❶ UL 508, CSA 22.2 No. 14 for group installation, in connection with short-circuit protection device.
- ❷ UL 508 Part III.
- ❸ UL 508 Part IV.
- ❹ Type E applications require use of the KT9/7-xx-TE terminal adaptor on KT9s and KT7s. Alternatively, the selection of a KT9/7 compact busbar supply block meet Type E requirements for terminal spacing.

It should be noted that the KT9/7 Manual Motor Circuit Controller, when listed as a self-protected (Type E) device, is rated for Wye-connected power systems for voltages above 240 volts (i.e. 480Y/277 volts common in the United States or 600Y/347 volts common in Canada).

F
 KT9 Motor Circuit Controllers

KTC9 Base Unit

Maximum Horsepower				Current Adjustment Range [A]	Magnetic Release Response Current [A]	Catalog Number
Typical Three Phase [HP]						
200V	230V	460V	575V			
KTC9-40H – High Interrupting Capacity						
~	~	~	~	0.10...0.16	3.2	KTC9-40H-0.16A
~	~	~	~	0.16...0.25	5.5	KTC9-40H-0.25A
~	~	~	~	0.25...0.40	8.8	KTC9-40H-0.4A
~	~	~	~	0.40...0.63	14	KTC9-40H-0.63A
~	~	1/2	1/2	0.63...1.0	22	KTC9-40H-1.0A
~	~	3/4	~	1.0...1.6	35	KTC9-40H-1.6A
1/2	1/2	1	1-1/2	1.6...2.5	55	KTC9-40H-2.5A
3/4	3/4	2	3	2.5...4	88	KTC9-40H-4.0A
1	1-1/2	3	5	4...6.3	139	KTC9-40H-6.3A
2	2	5	7-1/2	6.3...10	220	KTC9-40H-10A
3	5	10	10	10...16	320	KTC9-40H-16A
5	5	10	15	14.5...2	400	KTC9-40H-20A
5	7-1/2	15	20	18...25	450	KTC9-40H-25A
KTC7-45H — High Interrupting Capacity						
7-1/2	7-1/2	15	20	18...25	416	KTC7-45H-25A
7-1/2	10	20	30	23...32	585	KTC7-45H-32A



KTC9-40H

Description

The KTC9 has a fixed magnetic trip set at 18...22x the maximum value of the current adjustment range (as opposed to the KTA9s magnetic trip of approximately 14x adjustment range.) KTC9 are typically used in applications where nuisance tripping might occur, as with some high efficiency motors.

F

KTC9 Motor Circuit Controllers

Horsepower ratings shown in the table are for reference only. The final selection of the controller depends on the actual motor full load current and service factor.

- For motor with service factor less than 1.15. Use motor nameplate full load current times 0.9 and choose the motor starter with the appropriate current range. Example: Motor F.L.C. = 4.2A; S.F. = 1.0. – 4.2A x 0.9 = 3.78A. Select Catalog Number KTC9-40H-4.0A.

KTC9 UL Ratings Application Chart

Device	Manual Controller for Group Installation ❶		Manual Controller as Motor Disconnect ❷		Suitable for Tap Conductor Protection		Self-Protected Type E Manual Combination Controller ❸❹		
	Max. Fuse or Circuit Breaker	Max. Short Circuit Current [kA]		Max. Short Circuit Current [kA]		Max. Short Circuit Current [kA]		Max. Short Circuit Current [kA]	
		480V	600V	480V	600V	480Y/277V	600Y/347V	480Y/277V	600Y/347V
KTC9-40H — High Interrupting Capacity									
KTC9-40H-0.16A	450	65	50	65	50	65	47	65	50
KTC9-40H-0.25A	450	65	50	65	50	65	47	65	50
KTC9-40H-0.4A	450	65	50	65	50	65	47	65	50
KTC9-40H-0.63A	450	65	50	65	50	65	47	65	50
KTC9-40H-1.0A	450	65	50	65	50	65	47	65	50
KTC9-40H-1.6A	450	65	50	65	50	65	30	65	50
KTC9-40H-2.5A	450	65	30	65	30	65	30	65	30
KTC9-40H-4.0A	450	65	30	65	30	65	30	65	30
KTC9-40H-6.3A	450	65	30	65	30	65	30	65	30
KTC9-40H-10A	450	65	30	65	30	65	30	65	30
KTC9-40H-16A	450	65	30	65	18	65	30	65	~
KTC9-40H-20A	450	65	30	65	30	65	~	65	~
KTC9-40H-25A	450	50	30	50	30	50	~	50	~
KTC7-45H — High Interrupting Capacity									
KTC7-45H-25A	600	65	30	65	30	65	30	65	30
KTC7-45H-32A	600	65	18	65	18	65	18	65	18

- ❶ UL 508, CSA 22.2 No. 14 for group installation, in connection with short-circuit protection device.
- ❷ UL 508 Part III.
- ❸ UL 508 Part IV.
- ❹ Type E applications require use of the KT9/7-xx-TE terminal adaptor on KT9s and KT7s. Alternatively, the selection of a KT9/7 compact busbar supply block meet Type E requirements for terminal spacing.

It should be noted that the KT9/7 Manual Motor Circuit Controller, when listed as a self-protected (Type E) device, is rated for Wye-connected power systems for voltages above 240 volts (i.e. 480Y/277 volts common in the United States or 600Y/347 volts common in Canada).

KTB9 Base Unit ②

Maximum Horsepower				① Rated Operational Current [A]	Magnetic Release Response Current [A]	Catalog Number
Typical Three Phase [HP]						
200V	230V	460V	575V			
KTB9-40H – High Interrupting Capacity						
~	~	~	~	0.16	2.2	KTB9-40H-0.16A
~	~	~	~	0.25	3.5	KTB9-40H-0.25A
~	~	~	~	0.40	5.6	KTB9-40H-0.4A
~	~	~	~	0.63	8.8	KTB9-40H-0.63A
~	~	1/2	1/2	1.0	14	KTB9-40H-1.0A
~	~	3/4	~	1.6	22	KTB9-40H-1.6A
1/2	1/2	1	1-1/2	2.5	35	KTB9-40H-2.5A
3/4	3/4	2	3	4	52	KTB9-40H-4.0A
1	1-1/2	3	5	6.3	88	KTB9-40H-6.3A
2	2	5	7-1/2	10	130	KTB9-40H-10A
3	5	10	10	16	208	KTB9-40H-16A
5	5	10	15	20	280	KTB9-40H-20A
5	7-1/2	15	20	25	325	KTB9-40H-25A
7-1/2	10	20	25	29	406	KTB9-40H-29A
7-1/2	10	20	30	32	448	KTB9-40H-32A
10	10	25	30	36	432	KTB9-40H-36A
10	10	30	30	40	480	KTB9-40H-40A
KTB7-45H — High Interrupting Capacity						
7-1/2	10	20	25	25	325	KTB7-45H-25A
7-1/2	10	25	30	32	416	KTB7-45H-32A
10	15	30	40	45	585	KTB7-45H-45A



KTB9-40H

Description

The KTB9 is designed without a thermal trip element (i.e., current adjustment range). It should be selected for applications where a separate motor overload protection device is used, such as on CLE7 Three Component Starters on page F76. Magnetic trip is approximately 14x operational current for the KTB9 (approximately 13x for the KTB7).

F

KT9 Motor Circuit Controllers

① APPLICATION NOTE: Product Selection for Heavy Duty Starting Applications using KTB9-40H and KTB7-45H Motor Circuit Controllers

The KTB9 / KTB7 Motor Circuit Controller is designed and tested to protect a motor circuit in case of a short circuit. A separate Sprecher + Schuh CEP7 overload relay with selectable trip class should be used to protect the motor against overload.

In Applications with motor starting times exceeding 10 seconds (heavy duty starting) the rated operational current (I_e) of the motor FLA must be multiplied by the following factors for selection of the KTB9 / KTB7 Motor Circuit Controller KTB9-40H and KTB7-45H.

Trip classes according to UL 508 Section 52 and IEC 60947-4-1

CLASS 10 = 1.00 CLASS 15 = 1.22 CLASS 20 = 1.42

CLASS 25 = 1.58 CLASS 30 = 1.73

The maximum number of motor starts in 25 cycles/hour with a minimum OFF-time of 120 seconds between cycles. This additional calculation and selecting a larger frame size is necessary to compensate (dissipate) the increased heat

resulting from long acceleration applications effecting the rated operational current of the KTB9 / KTB7.

Application Example:

Motor 480 VAC, 10 HP, I_e 14 FLA

Heavy duty starting application with start time of up to 18 seconds

Solution:

Starting time up to 18 seconds requires dimensioning for CLASS 20.

- Selection of the Motor Circuit Controller for Short Circuit Protection:

Multiply the rated operational current I_e with factor for CLASS 20:

$$I_e(20) = 14 \text{ A} \times 1.42 = 19.9 \text{ A}$$

- Select corresponding Sprecher + Schuh KTB9-40H or KTB7-45H from catalog using next higher current rating: KTB9-40H-25A

② Horsepower ratings shown in the table are for reference only. The final selection of the controller depends on the actual motor full load current and service factor.

- For motor with service factor less than 1.15. Use motor nameplate full load current times 0.9 and choose the motor starter with the appropriate current range. Example: Motor F.L.C. = 4.2A; S.F. = 1.0. – (4.2A x 0.9 = 3.78A). Select Catalog Number KTB9-40H-4.0A.

KTB9 UL Ratings Application Chart

Device	Manual Controller for Group Installation		Manual Controller as Motor Disconnect		Suitable for Tap Conductor Protection		
	Max. Fuse or Circuit Breaker	Max. Short Circuit Current [kA]		Max. Short Circuit Current [kA]		Max. Short Circuit Current [kA]	
		480V	600V	480V	600V	480Y/277V ❶	600Y/347V ❶
KTB9-40H — High Interrupting Capacity							
KTB9-40H-0.16A	450	65	50	65	50	65	50
KTB9-40H-0.25A	450	65	50	65	50	65	50
KTB9-40H-0.4A	450	65	50	65	50	65	50
KTB9-40H-0.63A	450	65	50	65	50	65	50
KTB9-40H-1.0A	450	65	50	65	50	65	50
KTB9-40H-1.6A	450	65	50	65	50	65	50
KTB9-40H-2.5A	450	65	30	65	30	65	30
KTB9-40H-4.0A	450	65	30	65	30	65	30
KTB9-40H-6.3A	450	65	30	65	30	65	30
KTB9-40H-10A	450	65	30	65	30	65	30
KTB9-40H-16A	450	65	30	65	30	65	30
KTB9-40H-20A	450	65	30	65	30	65	~
KTB9-40H-25A	450	50	30	50	30	50	~
KTB9-40H-29A	450	50	30	50	30	50	~
KTB9-40H-32A	450	50	30	30	18	30	~
KTB9-40H-36A ❷	450	30	30	30	18	30	~
KTB9-40H-40A ❷	450	30	30	30	18	30	~
KTB7-45H — High Interrupting Capacity							
KTB7-45H-25A	600	65	30	65	30	~	~
KTB7-45H-32A	600	65	30	65	30	~	~
KTB7-45H-45A	600	65	18	65	18	~	~

F
KT9 Motor Circuit Controllers

❶ For full voltage (delta) ratings above 277V or 347V, follow the NEC or CEC rules for group motor applications.

❷ Suitable for continuous operation at 90% current rating at 480V only if used in a minimum enclosure size of 250 x 175 x 150 mm (10 x 7 x 6 in).

KTV9 Base Unit

Rated Operational Current (I _e) [A]	Current Adjustment Range [A]	Nominal Magnetic Trip Current [A]	Maximum Short Circuit Current [kA]		Maximum Horsepower Typical ①② Three Phase [HP]				Catalog Number
			480Y/277V Type E	480V (group motor)	200V	230V	460V	575V	
KTV9-40H – High Interrupting Capacity									
1.6	1.0...1.6	88	65	65	~	~	3/4	~	KTV9-40H-1.6A
2.5	1.6...2.5	88	65	65	1/2	1/2	1	~	KTV9-40H-2.5A
4.0	2.5...4.0	88	65	65	3/4	3/4	2	~	KTV9-40H-4.0A
6.3	4.0...6.3	88	65	65	1	1-1/2	3	~	KTV9-40H-6.3A
10	6.3...10	140	65	65	2	2	5	~	KTV9-40H-10A
16	10...16	224	65	65	3	5	10	~	KTV9-40H-16A
20	14.5...20	280	65	65	5	5	10	~	KTV9-40H-20A
25	18...25	350	50	50	5	7-1/2	15	~	KTV9-40H-25A
29	23...29	406	50	50	7-1/2	10	20	~	KTV9-40H-29A
32	24.5...32	448	30	50	7-1/2	10	20	~	KTV9-40H-32A
36	30...36	432	30	30	10	10	25	~	KTV9-40H-36A ③
40	34...40	480	30	30	10	10	30	~	KTV9-40H-40A ③



KTV9-40H

Description

The Sprecher+Schuh KTV9 series motor controllers are suitable for two types of applications under cULus listings:

- (1) as a Manual, Self-protected Motor Controller or
- (2) as a Manual Motor Controller with approval for group installation (and as a motor disconnect)

When UL/CSA listed as a manual, self-protected combination motor controller, the KTV9 provides all of the necessary NEC requirements for protection and control of individual motor branch circuits without additional protective devices (per NEC 430-52C option 6).

When KTV9 devices are applied as manual motor controllers in group installations, then NEC group installation rules state these devices must be applied per the appropriate rules, which require the use of an upstream BCPD-branch circuit protection device (per NEC 430-53C option 2).

The output frequency of the VFD must be limited to 400Hz or less to prevent thermal degradation. Various models of the KTV9 series self-protected combination motor controllers provide disconnection for motor branch circuits, branch-circuit and short-circuit protection (including magnetic protection), overload/thermal protection and manual switching.

The KTV9 self-protected combination motor controllers are current limiting and have a fixed magnetic trip. Interrupt ratings at 400V and 480V are available up to 65kAIC. The VFD output pulse-width modulation frequency must be limited to 4 kilohertz or less. The circuit breakers provide motor overload protection with a trip class 10 characteristic.

Horsepower ratings shown in the table are for reference only. The final selection of the controller depends on the actual motor full load current and service factor.

- For motor with service factor less than 1.15. Use motor nameplate full load current times 0.9 and choose the motor starter with the appropriate current range.
Example: Motor F.L.C. = 4.2A; S.F. = 1.0. – 4.2A x 0.9 = 3.78A.
Select Catalog Number KTV9-40H-4.0A.

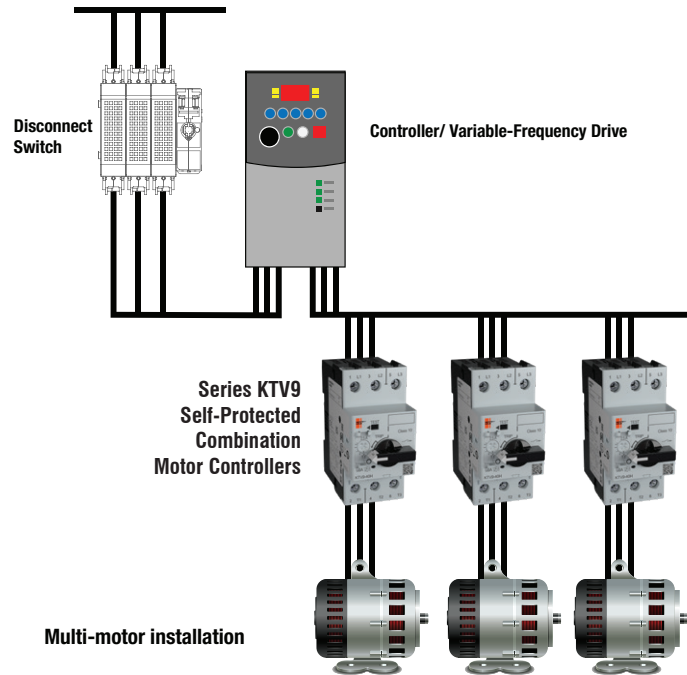

① HP ratings shown are for reference. Final selection of MPCB is determined by actual motor full load current.

② Not applicable at 575V.

③ Suitable for continuous operation at 90% current rating at 480V only if used in a minimum enclosure size of 250 x 175 x 150mm (10 x 7 x 6 in.)

KTV9 UL Ratings Application Chart

Device	Manual Controller for Group Installation		Manual Controller as Motor Disconnect		Suitable for Tap Conductor Protection		Self-Protected Type E Manual Combination Controller		
	Max. Fuse or Circuit Breaker	Max. Short Circuit Current [kA]		Max. Short Circuit Current [kA]		Max. Short Circuit Current [kA]		Max. Short Circuit Current [kA]	
		480V	600V	480V	600V	480Y/277V ❶	600Y/347V ❶	480Y/277V ❶	600Y/347V ❶
KTV9-40H — High Interrupting Capacity									
KTV9-40H-1.6A	450	65	~	65	~	65	~	65	~
KTV9-40H-2.5A	450	65	~	65	~	65	~	65	~
KTV9-40H-4.0A	450	65	~	65	~	65	~	65	~
KTV9-40H-6.3A	450	65	~	65	~	65	~	65	~
KTV9-40H-10A	450	65	~	65	~	65	~	65	~
KTV9-40H-16A	450	65	~	65	~	65	~	65	~
KTV9-40H-20A	450	65	~	65	~	65	~	65	~
KTV9-40H-25A	450	50	~	50	~	50	~	50	~
KTV9-40H-29A	450	50	~	50	~	50	~	50	~
KTV9-40H-32A	450	50	~	30	~	30	~	30	~
KTV9-40H-36A ❷	450	30	~	30	~	30	~	30	~
KTV9-40H-40A ❷	450	30	~	30	~	30	~	30	~

❶ For full voltage (delta) ratings above 277V or 347V, follow the NEC or CEC rules for group motor applications.

❷ Suitable for continuous operation at 90% current rating at 480V only if used in a minimum enclosure size of 250 x 175 x 150 mm (10 x 7 x 6 in).







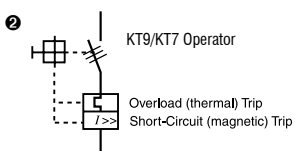



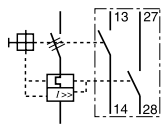

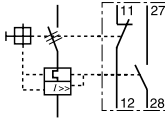

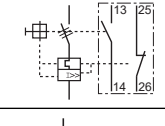

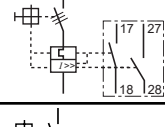
Accessories for KT9

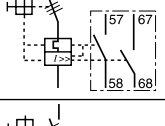
Accessory	Description	Operator Position ❶			Term. No.	Type	Connection Diagram and Terminal Markings ❷	For Use With	Catalog Number	
		OFF	ON	Tripped						
		0	X	0	13-14	1 NO		KT_9-32S KT_9-40H KTU9	KT9-PE1-10	
								KT_7-45H	KT7-PE1-10	
		X	0	X	11-12	1 NC		KT_7-45H	KT7-PE1-01	
		0	X	0	13-14	1 NO		KT_9-32S KT_9-40H KTU9	KT9-PE1-11	
	Front-Mounted Auxiliary Contact • 1-pole or 2-pole • No additional space required • Only one per device. • KT9-PE1...250V max. • KT7-PE1...300V max.	X	0	X	21-22	1 NC			KT_9-32S KT_9-40H KTU9	KT9-PE1-11
		0	X	0	13-14	1 NO	KT_7-45H		KT7-PE1-11	
		X	0	X	21-22	1 NC		KT_9-32S KT_9-40H KTU9	KT9-PE1-20	
		0	X	0	13-14	1 NO		KT_7-45H	KT7-PE1-20	
		0	X	0	23-24	1 NO		KT_9-32S KT_9-40H KTU9	KT9-PE1-20	
		0	X	0	13-14	1 NO		KT_7-45H	KT7-PE1-20	
		0	X	0	23-24	1 NO		KT_9-32S KT_9-40H KTU9	KT9-PE1-20	
		X	0	X	11-12	1 NC		KT_7-45H	KT7-PE1-02	
		X	0	X	21-22	1 NC				
			Right Side-Mounted Auxiliary Contact • 2-pole • Adds 9 mm to the width of the device. • 600V max. • One per device. • Not suitable for UL489 applications	0	X	0	33-34	1 NO		KT_9-32S KT_9-40H KTU9
0	X			0	43-44	1 NO	KT_7-45H	KT7-PA1-20		
0	X			0	33-34	1 NO		KT_9-32S KT_9-40H KTU9	KT9-PA1-02	
X	0			X	31-32	1 NC		KT_7-45H	KT7-PA1-02	
X	0			X	41-42	1 NC		KT_9-32S KT_9-40H KTU9	KT9-PA1-11	
X	0			X	41-42	1 NC		KT_7-45H	KT7-PA1-11	
0	X			0	33-34	1 NO		KT_9-32S KT_9-40H KTU9	KT9-PA1-11	
X	0			X	41-42	1 NC		KT_7-45H	KT7-PA1-11	
0	X			0	33-34	1 NO				
X	0			X	41-42	1 NC				

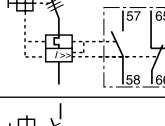
❶ X=Contact Closed
0=Contact Open

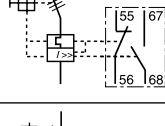

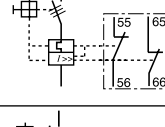
Accessories for KT9

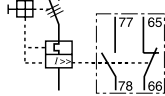

Accessory	Description	Operator Position ❶			Term No.	Type	Connection Diagram and Terminal Markings ❷	For Use With	Catalog Number							
		OFF	ON	Tripped												
 <p>Front-Mounted Trip Contact</p> <ul style="list-style-type: none"> • 2-pole • Indicates tripping of device • No additional space required • KT9-PEF1...250V max. • KT7-PEF1...300V max 	<p>0 X 0</p> <p>0 0 X</p> <p>0 X 0</p> <p>0 0 X</p> <p>X 0 X</p> <p>0 0 X</p> <p>X 0 X</p> <p>0 0 X</p> <p>0 X 0</p> <p>X X 0</p> <p>0 0 X</p> <p>0 0 X</p>	13-14	NO Aux		KT 9-32S KT 9-40H KTU9	KT9-PEF1-S10-N10										
		27-28	NO Trip (Short-Circuit & Overload)		KT 7-45H		KT7-PEF1-S10-N10									
		 <p>Right Side-Mounted Trip Contact</p> <ul style="list-style-type: none"> • 2-pole • Indicates tripping of motor protector • Adds 9 mm to the width of the device • 600V max. • Only one per device • A right-side mounted auxiliary contactor may be tandem on top of this trip contact. 	<p>0 0 X</p> <p>0 0 X</p> <p>X X 0</p> <p>X X 0</p> <p>0 0 X</p> <p>X X 0</p> <p>X X 0</p> <p>0 0 X</p> <p>X X 0</p> <p>0 0 X</p> <p>X X 0</p>	11-12	NC Aux		KT 9-32S KT 9-40H KTU9	KT9-PEF1-S10-N01								
				27-28	NO Trip (Short-Circuit & Overload)		KT 7-45H		KT7-PEF1-S10-N01							
				 <p>Right Side-Mounted Trip Contact</p> <ul style="list-style-type: none"> • 2-pole • Indicates tripping of motor protector • Adds 9 mm to the width of the device • 600V max. • Only one per device • A right-side mounted auxiliary contactor may be tandem on top of this trip contact. 	<p>0 X 0</p> <p>X X 0</p> <p>0 0 X</p> <p>0 0 X</p> <p>X X 0</p> <p>X X 0</p> <p>0 0 X</p> <p>X X 0</p> <p>0 0 X</p> <p>X X 0</p>	13-14	NO Aux		KT 9-32S KT 9-40H KTU9	KT9-PEF1-S01-N10						
						25-26	NC Trip (Short-Circuit & Overload)		KT 7-45H		KT9-PEF1-S10-M10					
						 <p>Right Side-Mounted Trip Contact</p> <ul style="list-style-type: none"> • 2-pole • Indicates tripping of motor protector • Adds 9 mm to the width of the device • 600V max. • Only one per device • A right-side mounted auxiliary contactor may be tandem on top of this trip contact. 	<p>0 0 X</p> <p>0 0 X</p> <p>X X 0</p> <p>X X 0</p> <p>0 0 X</p> <p>X X 0</p> <p>X X 0</p> <p>0 0 X</p> <p>X X 0</p> <p>0 0 X</p> <p>X X 0</p>	17-18	NO Trip (Short-Circuit & Overload)		KT 9-32S KT 9-40H KTU9	KT9-PEF1-S10-M10				
								27-28	NO Trip (Short-Circuit)		KT 7-45H		KT7-PAF1-S10-M10			
								 <p>Right Side-Mounted Trip Contact</p> <ul style="list-style-type: none"> • 2-pole • Indicates tripping of motor protector • Adds 9 mm to the width of the device • 600V max. • Only one per device • A right-side mounted auxiliary contactor may be tandem on top of this trip contact. 	<p>0 0 X</p> <p>0 0 X</p> <p>X X 0</p> <p>X X 0</p> <p>0 0 X</p> <p>X X 0</p> <p>X X 0</p> <p>0 0 X</p> <p>X X 0</p> <p>0 0 X</p> <p>X X 0</p>	57-58	NO Trip (Short-Circuit & Overload)		KT 7-45H	KT7-PAF1-S10-M01		
										67-68	NO Trip (Short-Circuit)		KT 7-45H		KT7-PAF1-S10-M01	
										 <p>Right Side-Mounted Trip Contact</p> <ul style="list-style-type: none"> • 2-pole • Indicates tripping of motor protector • Adds 9 mm to the width of the device • 600V max. • Only one per device • A right-side mounted auxiliary contactor may be tandem on top of this trip contact. 	<p>0 0 X</p> <p>0 0 X</p> <p>X X 0</p> <p>X X 0</p> <p>0 0 X</p> <p>X X 0</p> <p>X X 0</p> <p>0 0 X</p> <p>X X 0</p> <p>0 0 X</p> <p>X X 0</p>	57-58	NO Trip (Short-Circuit & Overload)		KT 7-45H	KT7-PAF1-S01/M10
												65-66	NC Trip (Short-Circuit)		KT 7-45H	
 <p>Right Side-Mounted Trip Contact</p> <ul style="list-style-type: none"> • 2-pole • Indicates tripping of motor protector • Adds 9 mm to the width of the device • 600V max. • Only one per device • A right-side mounted auxiliary contactor may be tandem on top of this trip contact. 	<p>0 0 X</p> <p>0 0 X</p> <p>X X 0</p> <p>X X 0</p> <p>0 0 X</p> <p>X X 0</p> <p>X X 0</p> <p>0 0 X</p> <p>X X 0</p> <p>0 0 X</p> <p>X X 0</p>											55-56	NC Trip (Short-Circuit & Overload)		KT 7-45H	KT7-PAF1-S01/M01
												67-68	NO Trip (Short-Circuit)		KT 7-45H	
		 <p>Right Side-Mounted Trip Contact</p> <ul style="list-style-type: none"> • 2-pole • Indicates tripping of motor protector • Adds 9 mm to the width of the device • 600V max. • Only one per device • A right-side mounted auxiliary contactor may be tandem on top of this trip contact. 	<p>0 0 X</p> <p>0 0 X</p> <p>X X 0</p> <p>X X 0</p> <p>0 0 X</p> <p>X X 0</p> <p>X X 0</p> <p>0 0 X</p> <p>X X 0</p> <p>0 0 X</p> <p>X X 0</p>									55-56	NC Trip (Short-Circuit & Overload)		KT 7-45H	KT7-PAF1-S01-M01
												65-66	NC Trip (Short-Circuit)		KT 7-45H	
				 <p>Right Side-Mounted Trip Contact</p> <ul style="list-style-type: none"> • 2-pole • Indicates tripping of motor protector • Adds 9 mm to the width of the device • 600V max. • Only one per device • A right-side mounted auxiliary contactor may be tandem on top of this trip contact. 	<p>0 0 X</p> <p>0 0 X</p> <p>X X 0</p> <p>X X 0</p> <p>0 0 X</p> <p>X X 0</p> <p>X X 0</p> <p>0 0 X</p> <p>X X 0</p> <p>0 0 X</p> <p>X X 0</p>							77-78	NO Trip (Short-Circuit)		KT 7-45H	KT7-PAF1-M11
												65-66	NC Trip (Short-Circuit)		KT 7-45H	

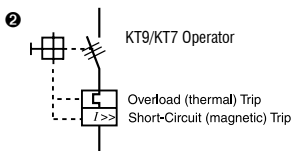
❶ X=Contact Closed
O=Contact Open



F
KT9 Motor Circuit Controllers

Accessories for KT9

Accessory	Description	For Use With	AC Coil Voltage		Catalog Number	
			50 Hz	60 Hz	Shunt Trip	Undervoltage
	<p>Undervoltage Trip</p> <ul style="list-style-type: none"> Left-side mounted Adds 18mm to the width of the device Automatically trips MPCD/MCP when voltage falls below 35...70% <p>Shunt trip</p> <ul style="list-style-type: none"> Left-side mounted Adds 18mm to width of device. Provides remote tripping of the MPCB/MCF Maximum on time for DC operated devices: 5 sec. 	KTA9 KTB9 KTC9 KTV9 KTU9 ③	24V	24...28V	KT9-AA-24V	KT9-UA-24V
			110V	120V	KT9-AA-120V	KT9-UA-120V
			220...230V	~	KT9-AA-230V	KT9-UA-230V
			~	240...260V	KT9-AA-260V	KT9-UA-260V
			~	277V	KT9-AA-277V	~
			380...400V	~	KT9-AA-400V	KT9-UA-400V
			415V	480V	KT9-AA-480V	KT9-UA-480V
			DC Coil Voltage		Shunt Trip	Undervoltage
			~	24VDC	KT9-AA-24D	~
				<p>Undervoltage Trip</p> <ul style="list-style-type: none"> Left-side mounted Adds 18 mm to the width of the KT7 device Automatically trips motor protector when voltage falls below 35...70% <p>Shunt Trip</p> <ul style="list-style-type: none"> Left-side mounted Adds 18 mm to the width of the KT7 device Trips motor protector when voltage is applied remotely 	KTA7 KTB7 KTC7	AC Coil Voltage
12V	14V	KT7-AA-14V				KT7-UA-14V
21V	24V	KT7-AA-24V				KT7-UA-24V
24V	28V	KT7-AA-28V				KT7-UA-28V
42V	48V	KT7-AA-48V				KT7-UA-48V
110V	120V	KT7-AA-120V				KT7-UA-120V
110V	127V	KT7-AA-127V				KT7-UA-127V
220...230V	~	KT7-AA-230V				KT7-UA-230V
~	240...260V	KT7-AA-240V				KT7-UA-240V
240V	277V	KT7-AA-277V				KT7-UA-277V
380V	460V	KT7-AA-460V				KT7-UA-460V
415V	480V	KT7-AA-480V				KT7-UA-480V
525V	600V	KT7-AA-600V				KT7-UA-600V
DC Coil Voltage		Shunt Trip				Undervoltage
9V DC		KT7-AA-9D				KT7-UA-9D
12V DC		KT7-AA-12D				KT7-UA-12D
24V DC		KT7-AA-24D				KT7-UA-24D
36V DC		KT7-AA-36D				KT7-UA-36D
48V DC		KT7-AA-48D				KT7-UA-48D
60V DC		KT7-AA-60D	KT7-UA-60D			
64V DC		KT7-AA-64D	KT7-UA-64D			
72V DC		KT7-AA-72D	KT7-UA-72D			
80V DC		KT7-AA-80D	KT7-UA-80D			

F

KT9 Motor Circuit Controllers

Undervoltage Trip Connection Diagram

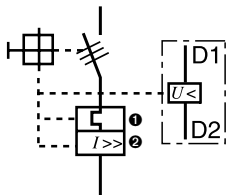

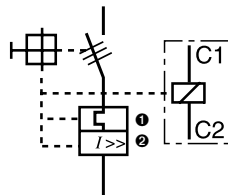

Shunt Trip Connection Diagram





- ① For Overload (thermal) Trip of KT9/KT7.
- ② For Short-Circuit (magnetic) Trip of KT9/KT7.
- ③ (UL 489 application up to 30 A)



Classic Handle Assembly, Type 1/4/4X/12

Accessory	Description	Color	Legend	For use with...	Frame Size (Length)	Catalog Number
	Classic Door Coupling Handle <ul style="list-style-type: none"> For 3 padlocks 4...8 mm (5/16") diameter Type 1/3/3R/4/4X/12 and IP66 Interlock override capability Can be modified for locking in ON position Ships with coupling — order extension shaft and legend plate separately See Technical Section for mounting depth information 	Gray/Black	0 - I OFF - ON Trip	KT_9-32S, KT_9-40H, KTU9	65 x 65mm	KT9-HTN
				KT_7-45H		KT7-HTN
		Red/Yellow	0 - I OFF - ON Trip	KT_9-32S, KT_9-40H, KTU9	65 x 65mm	KT9-HTRY
				KT_7-45H		KT7-HTRY
	Extension Shaft <ul style="list-style-type: none"> Cut to required length for mounting depth (front of DIN Rail to front of enclosure door) See Technical Section for mounting depth information 			KT9-HTN KT9-HTRY	250 mm	KT9-HT
		KT7-HTN KT7-HTRY	KT7-HT			
				KT9-HTN KT9-HTRY	400 mm	KT9-HTL
		KT7-HTN KT7-HTRY	KT7-HTL			

Contemporary Handle Assembly, Type 3R/3/4/4X

Accessory	Description	Color	Legend	For use with...	Frame Size (Length)	Catalog Number
	Contemporary Door Coupling Handle <ul style="list-style-type: none"> Screw Fixing Type 3R, 3, 12, 4, 4X, IP66 Field configurable for defeatable or non-defeatable Ships with coupling — order extension shaft and legend plate separately Requires 30mm hole for mounting For up to 2 padlocks 	Black/Black	0 - I OFF - ON Trip	KT_9-32S, KT_9-40H, KTU9	48.7 x 47mm	KT9-SB
				KT_7-45H		KT7-SB
		Red/Yellow	0 - I OFF - ON Trip	KT_9-32S, KT_9-40H, KTU9	48.7 x 47mm	KT9-SY
				KT_7-45H		KT7-SY
	Extension Shaft <ul style="list-style-type: none"> Cut to required length for mounting depth (front of DIN Rail to front of enclosure door) See Technical Section for mounting depth information 			KT9-SB KT9-SY	305mm (12")	KT9-S1
		KT7-SB KT7-SY	KT7-S1			
				KT9-SB KT9-SY	533mm (21")	KT9-S2
		KT7-SB KT7-SY	KT7-S2			

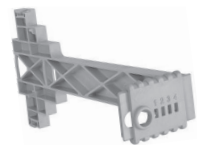





Handle Accessories

Accessory	Description	For use with...	Catalog Number
	Coupler <ul style="list-style-type: none"> Coupler for extension shaft Included with KT9-HTN/HTRY and KT9-SB/SY handles 	KTA9-32S, KT_9-40H KTU9-40H	KT9-DNC
	Extension Shaft Support <ul style="list-style-type: none"> Provides consistent alignment of the shafts with handle or door coupling Recommended for shaft lengths >200mm (7.8 in) 9mm in width and snaps on right side of devices Allows for one side-mount auxiliary 	KT_9-32S, KT_9-40H, KTU9	KT9-SHS
		KT_7-45H	KT7-SHS
	Legend Plate <ul style="list-style-type: none"> Marking: "Hauptschalter" and "Main Switch" (Black/Gray) Marking: "Not-Aus" and "Emergency Off" (Black/Yellow) 	KT9-HT_	KT9-HTFCN
		KT7-HT_	KT7-HTFCN
		KT9-HT_	KT9-HTFCRY
		KT7-HT_	KT7-HTFCRY

1 See Dimensions and Technical data in this section for design compatibility.

2 See page F41 for assembly example and dimensions.

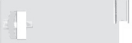
Accessories for KT9

Accessory	Description	Color	For Use With	Catalog Number	
  	Lockable Twist Knob <ul style="list-style-type: none"> For 1 padlock 4...6 mm (3/16 in.) diameter shackle Can be locked in OFF position 	Black	KT_9-32S, KT_9-40H, KTU9	KT9-KN	
				KT_7-45H	KT7-KN1
	Locking Tag <ul style="list-style-type: none"> Padlock attachment to the lockable handles Up to three padlocks 4...8 mm (5/16 in.) dia. shackle 	Red/Yellow	KT_9-32S, KT_9-40H, KTU9	KT9-KRY	
				KT_7-45H	KT7-KRY1
			Red	KT9-KN KT9-KRY1	KT9-M3
				KT7-KN1 KT7-KRY1	KT7-DS
	Terminal Adapter for Type E Applications ⓘ <ul style="list-style-type: none"> Required for self-protected combination motor controller (Type E) application of KT_9-32S, KT_9-40H and KT_7-45H Not for use with bus bars 		KT_9-32S, KT_9-40H	KT9-40-TE	
				KT_7-45H	KT7-45-TE
	Anti-Tamper Shield <ul style="list-style-type: none"> Provides protection against inadvertent adjustment of the current setting Sold only in packages of 10. Order 10 pieces to receive 1 pkg. of 10 		KT_9-32S, KT_9-40H	KT9-CA	
				KT_7-45H	KT7-25-CA
	Screw Adaptor <ul style="list-style-type: none"> For screw fixing of motor protection circuit breaker Sold only in packages of 10. Order 10 pieces to receive 1 pkg. of 10 		KT_9-32S, KT_9-40H, KTU9	KT9-N45	
				KT_7-45H	KT7-45-AS

KT9 Motor Circuit Controllers

Marking Systems

Component	Description	Pkg. Qty.	Catalog Number
	Label Sheet - 1 sheet with 105 self-adhesive paper labels each, 6 x17mm	1	CA7-FMS

ⓘ Terminal Adaptors are supplied as standard on enclosed KT9 and CX7 starters, as well as, CLE- assembled products, assuring they can be used in Type E applications. Alternatively, compact busbar supply block KT9- _A2E or -A3E meet Type E requirements for terminal spacing.

Connecting Modules (for connecting KTA7, KTB7 or KTC7 into KT_9 to CA8, CA7 AC coil, or CA7 Electronic DC coil contactors) ②

Module	Type	Description	For Connecting	Catalog Number ①
	ECO Connection Module 12A (IEC) , 11A (UL)	<ul style="list-style-type: none"> For DOL and reversing starters Eco-starters mount on single DIN Rail (KT_9 on DIN Rail) Electrical and mechanical interconnection of KT_9 and CA8 contactors 	KT_9-32S to CA8	KT9-32S-PEK12
	ECO Connection Module 25A (IEC) , 22A (UL)	<ul style="list-style-type: none"> Eco-starters mount on single DIN Rail (KT_9 on DIN Rail) Electrical and mechanical interconnection of KT_9 MPCB and CA7 (with AC coils or 24V DC electronic coils) contactors 	KT_9-32S to CA7-9...23	KT9-32S-PEC23
	ECO Connection Module 38A (IEC) , 34A (UL)		KT_9-40H to CA7-9...23	KT9-40H-PEC23
	ECO Connection Module KT9-...-PNC23 25A (IEC), 24A (UL) KT9-...-PNC37 38A (IEC), 34A (UL)	<ul style="list-style-type: none"> Contactor and MPCB MUST BE mounted separately on (2) DIN Rails Electrical interconnection of KT_9 and CA7 (with AC coils) 	KT_9-32S to CA7-9...23	KT9-32S-PNC23
			KT_9-40H to CA7-9...23	KT9-40H-PNC23
			KT_9-40H to CA7-30...37	KT9-40H-PNC37
	Connecting Modules — 25 and 45 A	<ul style="list-style-type: none"> Contactor and MPCB MUST BE mounted separately on (2) DIN Rails Electrical Interconnection of KT_7-45H and CA7 (with AC coils) 	KT_7-45H to CA7-30...37	KT7-45H-PNC37
		KT_7-45H to CA7-43	KT7-45H-PNC43	

Coil Modules

	Coil Extension Modules	<ul style="list-style-type: none"> Provides access to coil terminals on 3-component starters 	CA7-9...23	KT9-32S-PSC23
			CA7-30...55	KT9-80H-PSC43
			CA7-30...55	KT7-45H-PSC43

Type W Mounting Modules

Module	Description	Width (mm)	Catalog Number
	Short Mounting Module - Requires Connecting Module from tables above <ul style="list-style-type: none"> Provides support for KT7 + CA7 or CA8 Top rail is specifically designed for KT7 Bottom rail is movable for easy assembly and disassembly Complete unit mounts to two 35mm DIN-rails or one 70mm DIN-rail or screw mounts 228 mm long 	45	W-32489
		54	W-32490
	Long Mounting Module - See Section D for Connecting Modules <ul style="list-style-type: none"> Provides support for KT7 + PCS Softstarter, CA7 + PCS Softstarter or KTB7 + CA7+CEP7 Top rail is specifically designed for KT7 Bottom rail is movable for easy assembly and disassembly Complete unit mounts to two 35mm DIN-rails or one 70mm DIN-rail or screw mounts 283 mm long 	45	W-32496
		54	W-32497

① cURus Approved (File # E33916).

② Not for use with KTU9 Circuit Breakers

Compact Busbar System for KT_9 Motor Controllers ①

Accessory	Description	For Use With	Catalog Number
	<p>Compact Busbar — 45 mm Spacing (Rated 64 A)</p> <ul style="list-style-type: none"> For use with front-mounted auxiliary contact on KT_9 Motor Controllers Connects 2 Motor Controllers Connects 3 Motor Controllers Connects 4 Motor Controllers Connects 5 Motor Controllers 	KTA9-32S, KT_9-40H, KTU9	<p>KT9-40-DB-45-2</p> <p>KT9-40-DB-45-3</p> <p>KT9-40-DB-45-4</p> <p>KT9-40-DB-45-5</p>
	<p>Compact Busbar — 54 mm Spacing (Rated 64 A)</p> <ul style="list-style-type: none"> For use with side-mounted auxiliary contact on KT_9 Motor Controllers Connects 2 Motor Controllers Connects 3 Motor Controllers Connects 4 Motor Controllers Connects 5 Motor Controllers 	KTA9-32S, KT_9-40H, KTU9	<p>KT9-40-DB-54-2</p> <p>KT9-40-DB-54-3</p> <p>KT9-40-DB-54-4</p> <p>KT9-40-DB-54-5</p>
	<p>Compact Busbar — 54mm Spacing (Rated 115 A)</p> <ul style="list-style-type: none"> For use with front-mounted auxiliary contact on KT_7 Motor Controllers Connects 2 Motor Controllers Connects 3 Motor Controllers Connects 4 Motor Controllers 	KT_7-45H	<p>KT7-45-DB-54-2</p> <p>KT7-45-DB-54-3</p> <p>KT7-45-DB-54-4</p>
	<p>Compact Busbar — 63 mm Spacing (Rated 115 A)</p> <ul style="list-style-type: none"> For use with side-mounted auxiliary contact on KT_7 Motor Controllers Connects 2 Motor Controllers Connects 3 Motor Controllers Connects 4 Motor Controllers 	KT_7-45H	<p>KT7-45-DB-63-2</p> <p>KT7-45-DB-63-3</p> <p>KT7-45-DB-63-4</p>
<p>KTA9-32S to 40H KT9-KBH</p>	<p>Top Hat Rail Adapter — 10 mm</p> <ul style="list-style-type: none"> Adjust the depth of the KTA9-32S to the KT_9-40H Allows the use of compact busbars across both frame sizes Must be ordered in multiples of 10 Sold only in packages of 10. Order 10 pieces to receive 1 pkg. of 10 	KTA9-32S	KT9-KBH
<p>KT9-40-A2E</p>	<p>Feeder Block for Compact Busbar</p> <ul style="list-style-type: none"> Supply of compact busbars Increases terminal capacity 	KTA9-32S	KT9-40-A2E
		KT_7-45H	KT7-45-A2E
<p>KT9-40-A3E</p>	<p>Feeder Terminal for Compact Busbar</p> <ul style="list-style-type: none"> For supply of compact busbars Top feed — overlaps compact busbar Meets UL Type E spacing requirements 	KTA9-32S, KT_9-40H	KT9-40-A3E
		KT_7-45H	KT7-45-A3E
	<p>Terminal Cover</p> <ul style="list-style-type: none"> For covering of unused compact bus bar terminals IP2X finger protection Must be ordered in multiples of 10 Sold only in packages of 10. Order 10 pieces to receive 1 pkg. of 10 	KT9-40-DB	KT9-40-DBA
		KT7-45-DB	KT7-45-DBA

F KT9 Motor Circuit Controllers

① UL Approved (File #E33916); CSA Approved (File #13908).

General Data







Attribute	KT9-32S	KT9-40H	KT7-45H		
Standards compliance	IEC	IEC/EN 60947-2, IEC/EN 60947-4-1			
	cULus ①	UL 60947-4-1, CSA C22.2, No. 60947-4-1			
Certifications	Regional ①	CCC, EAC, CE, IEC, cULus Listed	cULus Listed, CCC, EAC, CE		
Rated Insulation Voltage U_i	IEC [V]	690			
	UL/CSA [V]	600			
Rated Impulse Withstand Voltage U_{imp}	Pollution degree				
	3				
	Main circuits U_{imp} /Overvoltage Category		6 kV/III, 8 kV (Disconnect)		
Auxiliary circuits U_{imp} /Overvoltage Category		6 kV/III			
Rated Frequency	[Hz]	45-65			
Utilization Category	IEC 60947-2 (Circuit breaker)	A			
	IEC 60947-4-1 (Motor starter)	AC-3			
Life Span	Mechanical [operations]	100,000	30,000		
	Electrical (I_e max.) [operations]	100,000	30,000		
Switching Frequency	[operations/hours]	max. 25			
Ambient Temperature	Storage [°C (°F)]	-40...+85°C (-40-185°F)			
	Operation [°C (°F)]	-25...+70°C (-13-158°F)			
Climatic resistance	Operating Humidity/Moisture heat (60068-2-3)	5...95% Non-condensing			
Site Altitude	[m]	to 2000 N.N. (6561 ft)			
Protection Class		IP2X from all directions			
Resistance to Shock, Transport (60068-2-27)	ON	15 G/11 ms			
	OFF	30 G/11 ms			
Resistance to Vibration, Operation (60068-2-6)		5 G			
Rated Thermal Current I_m	up to 40 °C (104 °F) ambient temperature	[A]	0.1...32	0.63...40	6.3...45
	up to 60 °C (140 °F) ambient temperature	[A]	0.1...32	0.63...40	6.3...45
Rated Supply Current I_e		[A]	0.1...32	0.63...40	6.3...45
Dependence on Temperature	40 °C (104 °F)	[A]	no reduction		
	50 °C (122 °F)	[A]	no reduction		
	60 °C (140 °F)	[A]	no reduction		
	70 °C (158 °F)	[A]	15% current reduction of the upper rated current I_e		
Overload Protection Characteristics		IEC 60947-4-1 Motor protection (except Cat. Nos. KTB9-40H, KTB7-45H)			
Ambient Temperature Compensation	[°C (°F)]	-25...+60 (-13...+140)			
Phase-loss Protection		Differential release			
Trip class		10 (except Cat. Nos. KTB9-40H, KTB7-45H) fixed setting			
Magnetic Release		fixed setting			
Release current ($\pm 20\%$)	for KTA9, KTB9	[A]	14 x I_e max. ②	13 x I_e max.	
	for KTA9, KTB9 36A, 40A	[A]	12 x I_e max. ②	~	
	for KTC9	[A]	18...22 x I_e max. ③		
Total Power loss P_v	Circuit Breaker at rated load/operating temp.	[W]	4...11	4...14	7...22
Main Disconnect Switch Application		Yes, with accessories			
Application Conditions	KT_9-40H...36A, -40A: Suitable for continuous operation at 90% current rating at 480V only if used in a minimum enclosure size of 250 x 175 x 150 mm (10 x 7 x 6 in).				
	For utilization outside North America, assemblies (of products) shall comply to the IEC 61439-1 requirements KT9 manual starters are intended for use in closed areas without hazardous operating conditions such as dust or explosive or corrosive gases. Enclosures of appropriate manner need to be in place to protect devices in such environments.				

① cULus Listing in process.

② I_e max. = maximum values of setting ranges fixed magnetic setting for KTV9-40H; see ratings.

③ I_e max. = maximum values of setting ranges; see ratings.

MPCB Connecting Characteristics

Connection	No. of conductors	KTA9-32S	KT_9-40H	KT_7-45H
Power Terminals				
Terminal Type		Screw Clamp up to 16 A, M4	Screw Clamp greater than 16 A, M4	
Screwdriver		Pozidriv No.2/Blade No.3	Pozidriv No.2/Blade No.3	Pozidrive No. 2/Blade No. 3
Solid or stranded 	1 conductor	1...6 mm ²	1.5...10 mm ²	2.5...25 mm ²
	2 conductor	1...2.5 mm ² 2.5...6 mm ²	1.5...4 mm ² 4...10 mm ²	2.5...25 mm ²
Flexible with ferrule (end sleeve) 	1 conductor	1...6 mm ²	1.5...10 mm ²	2.5...25 mm ²
	2 conductor	1...2.5 mm ² 2.5...4 mm ²	1.5...4 mm ² 4...10 mm ²	2.5...25 mm ²
Finely stranded 	1 conductor	1.5...6 mm ²	2.5...10 mm ²	16...25 mm ²
	2 conductor	1.5...4 mm ² 2.5...6 mm ²	2.5...6 mm ² 4...10 mm ²	16...25 mm ²
Cross section per UL/CSA solid, stranded 	1 conductor	No. 14...10 AWG	No. 14...8 AWG	No.14...8
	2 conductor	No. 14...10 AWG	No. 14...10 AWG No. 12...8 AWG	No.14...8
Stripping length		10 mm (0.39 in.)	10 mm (0.39 in.)	10 mm (0.39 in.)
Tightening torque	[Nm]/[lb-in.]	2...2.5 / 18...22	2...2.5/18...22	3...3.5 / 27...30

Approval Comparison



KTA9-32S



KT_9-40H



KT_7-45H

Features and Approvals

Max. Current I_n	32 A	32 A	45 A
Current Rating	0.1...32 A	0.63...40A	6.3...45 A
Short Circuit Protection	✓	✓	✓
Standard magnetic Trip	✓	✓	✓
High Magnetic Trip	✓	✓	✓
Magnetic Only Trip (MCP)	✓	✓	✓
Overload Protection	✓	✓	✓
Trip Class	✓	✓	✓
Application at output of VFD (multi-motor)		✓ (KTV9)	✓
Standards Compliance:			
CSA22.2, No. 14	✓	✓	✓
UL508 (Group Installation)	✓ (see ratings)	✓ (see ratings)	✓ (see ratings)
UL508 Manual, Self-protected (Type E)	✓ (see ratings)	✓ (see ratings)	✓ (see ratings)
UL508 (Overload Protection)	✓	✓	✓
IEC60947-1,-2	✓	✓	✓
IEC60947-4-1	✓	✓	✓
CE	✓	✓	✓
ATEX (IEC60079-14)	✓ (up to 25 A)	✓ (up to 25 A except KTV9)	✓
CCC	✓ (up to 25 A)	✓ (up to 25 A except KTV9)	✓
Accessories			
External Rotary Operator	✓	✓	✓
Auxiliary Contacts	✓	✓	✓
Trip Indicator Contacts	✓	✓	✓







Auxiliary Contact Specifications – for KTA9-32S... and KT_9-40H devices

Attribute		Front-mounted Auxiliary Contacts Cat. Nos. KT9-PE1, -PEF1/ -PEF1-S10M10		Right Side-mounted Auxiliary Contacts Cat. No. KT9-PA1
Rated Thermal Current I_{th}	at 40°C (104°F) ambient temperature	[A]	5	10
	at 60°C (140°F) ambient temperature	[A]	4	6
Back-up Fuses gG, gL		[A]	10	10
General Use current		[A]	5	10
Rated insulation voltage U_i	IEC	[V]	250	690
	UL/CSA	[V]	240	600
Contact rating code designation (UL/CSA)		AC	B300	A600
		DC	R300	Q600
Rated Supply Current I_e	AC-15	24V [A]	4	6
		120V [A]	3	5
		240V [A]	1.5	3
		415V [A]	-	2
		690V [A]	-	1
	DC-13	24V [A]	1.2	2
		125V [A]	0.22	0.55
		250V [A]	0.11	0.27
		400V [A]	-	0.15
		500V [A]	-	0.13
Type of Terminals				
Recommended Screwdriver			Pozidrive No. 2/Blade No. 3	Pozidrive No. 2/Blade No. 3
	Flexible with insulated ferrule	1 or 2 conductors	0.5...1.5 mm ² /No. 18...14 AWG	0.5...2.5 mm ² /No. 18...14 AWG
	Flexible	1 or 2 conductors	0.5...1.5 mm ² /No. 18...14 AWG	0.75...2.5 mm ² /No. 18...14 AWG
	Stranded per UL/CSA	1 or 2 conductors	0.5...1.5 mm ² /No. 18...14 AWG	0.75...2.5 mm ² /No. 18...14 AWG
	Solid	1 or 2 conductors	0.5...1.5 mm ² /No. 18...14 AWG	0.5...2.5 mm ² /No. 18...14 AWG
Conductor steps			Max 2 conductor steps allowed	Max 2 conductor steps allowed
Tightening torque			1...1.2 N•m/8.9...10.6 lb•in	1...1.2 N•m/8.9...10.6 lb•in/1...1.2

Auxiliary Contact Specifications – for KT_7-45H... devices



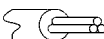

Attribute		Front-mounted Auxiliary Contacts Cat. Nos. 140M-C-AFA..., 140M-C-AFAR...		Right Side-mounted Auxiliary Contacts Cat. Nos. 140M-C-ASA..., 140M-C-ASAR...
Rated Thermal Current I_{th}	at 40°C (104°F) ambient temperature	[A]	5	10
	at 60°C (140°F) ambient temperature	[A]	4	6
Back-up Fuses gG, gL		[A]	10	10
Contact rating code designation (UL/CSA)		AC	B300	A600
		DC	R300	Q600
Rated Supply Current I_e	AC-15	24V [A]	4	6
		120V [A]	3	5
		240V [A]	1.5	3
		415V [A]	-	2
		690V [A]	-	0.7
	DC-13	24V [A]	2	2
		120V [A]	0.5	0.5
		240V [A]	0.25	0.25
		415V [A]	-	0.15
Type of Terminals				
Recommended Screwdriver			Pozidriv No. 2/Blade No.3	Pozidriv No. 2/Blade No.3
	Flexible with insulated ferrule	1 conductor	0.5...1.5 mm ²	0.5...2.5 mm ²
		2 conductors	0.75...1.5 mm ²	0.75...2.5 mm ²
	Stranded per UL/CSA	1 or 2 conductors	0.75...1.5 mm ² /No. 18...14 AWG	0.75...2.5 mm ² /No. 18...14 AWG
	Solid	1 or 2 conductors	0.75...1.5 mm ² /No. 18...14 AWG	0.75...2.5 mm ² /No. 18...14 AWG
Tightening torque			1...1.2 N•m/8.9...10.6 lb•in	1...1.2 N•m/8.9...10.6 lb•in/1...1.2

Undervoltage and Shunt Trip Specifications—For KTA9-32S... and KT_9-40H... devices

		Undervoltage Trip for Left-Side Mounting Cat. Number KT9-UA-*		Shunt Trip for Left-Side Mounting Cat. Number KT9-AA-*	
Actuating Voltage	Pull-in	0.85...1.1 x U _s		0.7...1.1 x U _s	
	Drop-out	0.7...0.35 x U _s		0.7...1.1 x U _s	
KT9-UA-24V	50 Hz	24		-	
	60 Hz	28		-	
KT9-UA-120V	50 Hz	110		-	
	60 Hz	120		-	
KT9-UA-230V	50 Hz	220...230		-	
	60 Hz	-		-	
KT9-UA-260V	50 Hz	-		-	
	60 Hz	240...260		-	
KT9-UA-400V	50 Hz	380...400		-	
	60 Hz	440...460		-	
KT9-UA-480V	50 Hz	415		-	
	60 Hz	480		-	
KT9-AA-24V	50 Hz	-		24	
	60 Hz	-		24...28	
KT9-AA-120V	50 Hz	-		110	
	60 Hz	-		120	
KT9-AA-230V	50 Hz	-		220...230	
	60 Hz	-		-	
KT9-AA-260V	50 Hz	-		-	
	60 Hz	-		240...260	
KT9-AA-277V	50 Hz	-		240	
	60 Hz	-		277	
KT9-AA-400V	50 Hz	-		380...400	
	60 Hz	-		440...460	
KT9-AA-480V	50 Hz	-		415	
	60 Hz	-		480	
On-time		Continuous duty		Continuous duty	
Coil consumption		8.5/8 4/2		8.5/8 4/2	
Rated DC Control Voltage	KT9-AA-24D	-		24	
	On-time	-		Max 5 s	
	Coil consumption Pick-up	-		50	
Type of Terminals					
Recommended screwdriver		POZIDRIVE No. 2/BLADE No. 3		POZIDRIVE No. 2/BLADE No. 3	
Flexible with insulated ferrule	 1 or 2 conductor	0.5...2.5 mm ² / No. 18...14 AWG		0.5...2.5 mm ² / No. 18...14 AWG	
Flexible	 1 or 2 conductor	0.75...2.5 mm ² / No. 18...14 AWG		0.75...2.5 mm ² / No. 18...14 AWG	
Stranded per UL/CSA	 1 or 2 conductor	0.75...2.5 mm ² / No. 18...14 AWG		0.75...2.5 mm ² / No. 18...14 AWG	
Solid	 1 or 2 conductor	0.5...2.5 mm ² / No. 18...14 AWG		0.5...2.5 mm ² / No. 18...14 AWG	
Conductor steps		Max 2 conductor steps allowed		Max 2 conductor steps allowed	
Tightening torque		1...1.2 N•m/8.9...10.6 LB•IN		1...1.2 N•m/8.9...10.6 LB•IN 1...1.2	

F
KT9 Motor Circuit Controllers

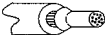
Undervoltage and Shunt Trip Specifications – For KT_7-45H... devices

Attribute		Undervoltage Trip for Left-Side Mounting Cat. Number KT7-UA-*		Shunt Trip for Left-Side Mounting Cat. Number KT7-AA-*		
Actuating Voltage	Pick-up	[V]	0.85...1.1 x U _s	0.7...1.1 x U _s		
	Drop-out	[V]	0.7...0.35 x U _s	0.7...1.1 x U _s		
Rated AC Control Voltage	Min	50 Hz	[V AC]	21	21	
		60 Hz	[V AC]	24	24	
	Max	60 Hz	[V AC]	600	600	
		On-time	Continuous duty		Continuous duty	
Coil consumption	Pick-up	[VA/W]	8.5/8	8.5/8		
	Hold-in	[VA/W]	4/2	4/2		
Type of Terminals						
Recommended Screwdriver			Pozidrive No. 2/Blade No. 3		Pozidrive No. 2/Blade No. 3	
	Flexible with insulated ferrule	1 conductor	0.5...2.5 mm ²		0.5...2.5 mm ²	
		2 conductors	0.75...2.5 mm ²		0.75...2.5 mm ²	
	Stranded per UL/CSA	1 or 2 conductors	0.75...2.5 mm ² /No. 18...14 AWG		0.75...2.5 mm ² /No. 18...14 AWG	
	Solid	1 or 2 conductors	0.75...2.5 mm ² /No. 18...14 AWG		0.75...2.5 mm ² /No. 18...14 AWG	
Conductor steps			1.2...1.5 N•m/10.6...13.3 lb•in		1.2...1.5 N•m/10.6...13.3 lb•in	

Time-Current Characteristic

KT9 KTA7 Motor Protection (for KTV9, see ratings)

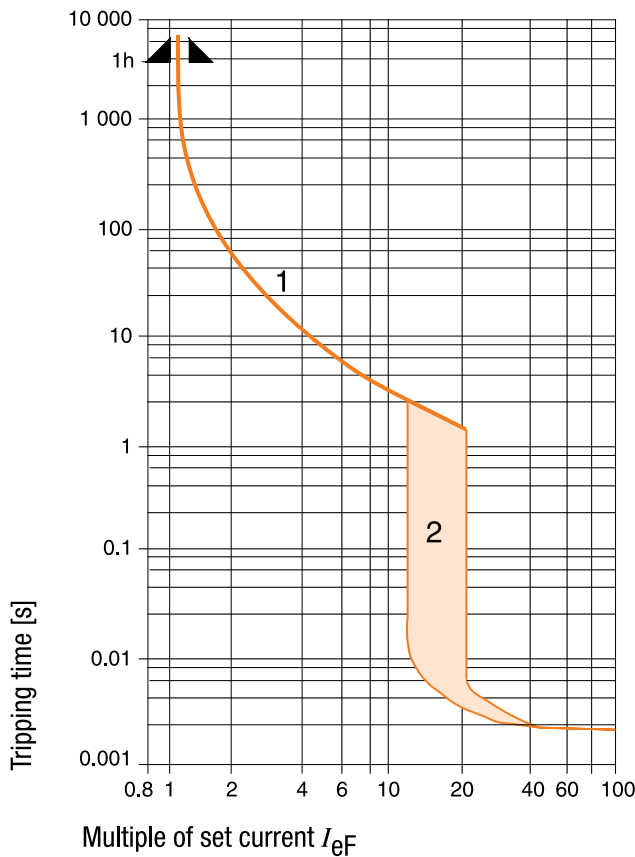

1. Thermal Release Trip Current

The adjustable current-dependent delayed bimetal release protects motors against overload. The curve shows the mean operating current at an ambient temperature of 20°C starting from the cold state. Careful testing and setting ensures effective motor protection even in the case of single-phasing. The overload characteristic is also valid for transformer protection.

2. Magnetic Release Trip Current

The instantaneous magnetic trip has a fixed operating current setting. This corresponds to 13...14 times the maximum value of setting range (high inrush protection -20 x I_e maximum). At a lower overload setting the magnetic trip is correspondingly higher.

Current Setting I_{ef}

The overload trip corresponds to a thermal overload relay in a motor starter conforming to IEC 947-4-1. If a different value is prescribed (e.g., reduced I_e for cooling medium having a temperature higher than 40°C or a place of installation higher than 2000m above sea level), the setting current is equal to the reduced rated current I_e of the motor.

F KT9 Motor Circuit Controllers

Cut-off Current ❶

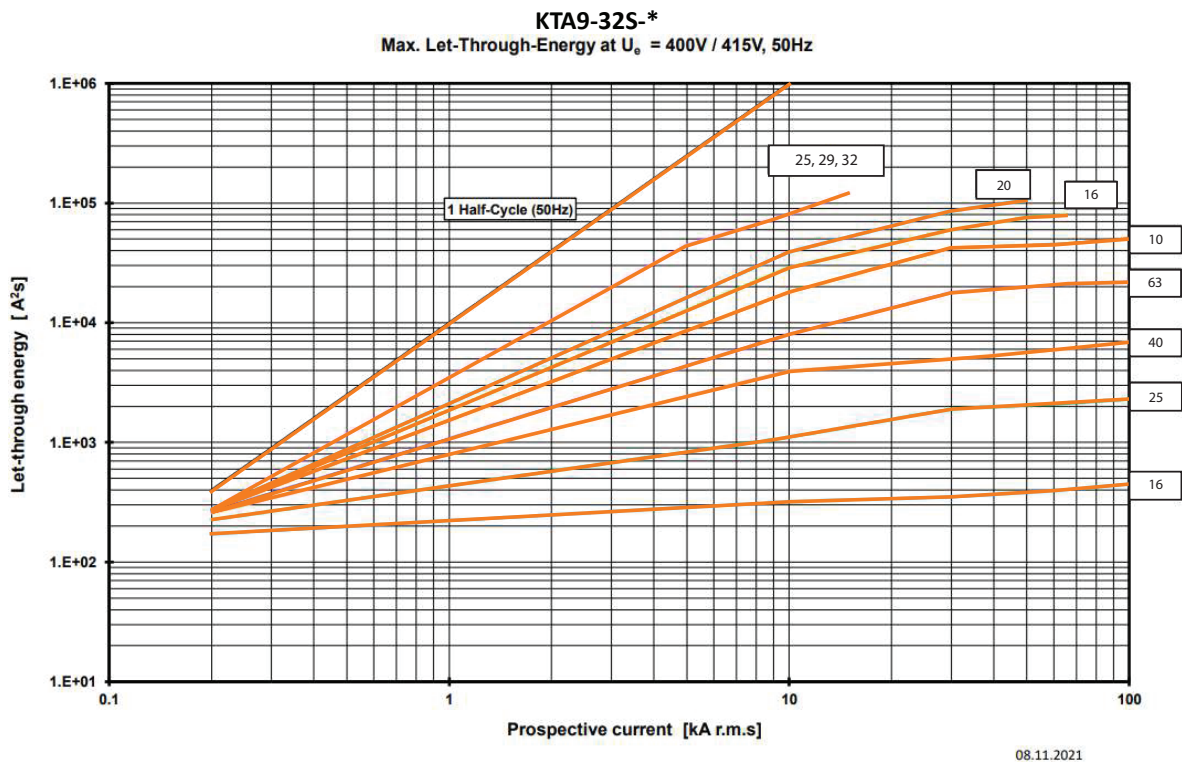
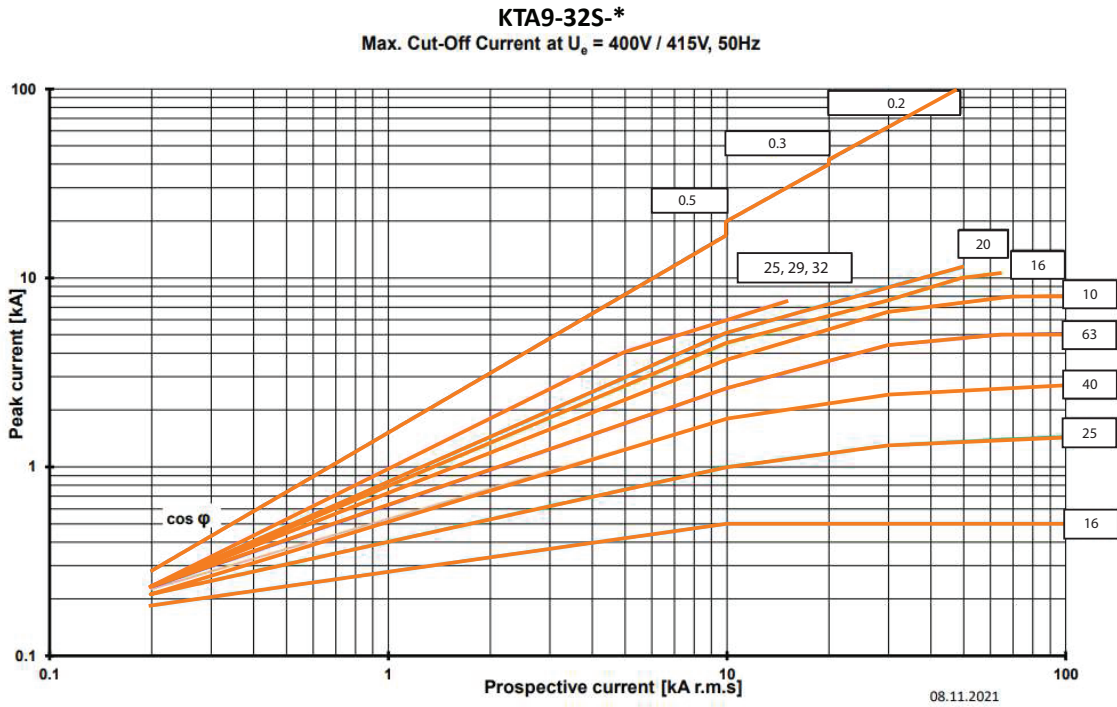

❶ A full size (8-1/2 x 11) set of "Maximum Cut-Off Current (Let-Thru Current)" and "Maximum Let-thru Energy (I²t)" curves for 400...415V, 500V and 690V can be downloaded from <http://www.sprechersschuh.com>.

Cut-off Current ①

F
 KT9 Motor Circuit Controllers

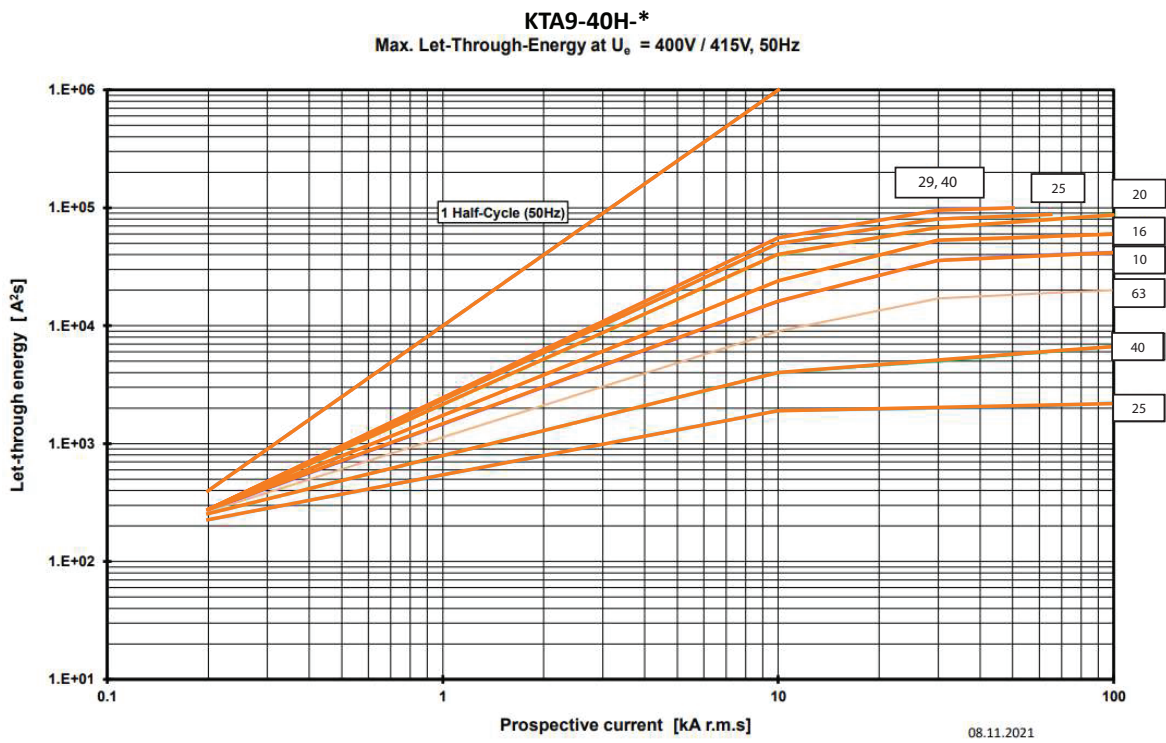
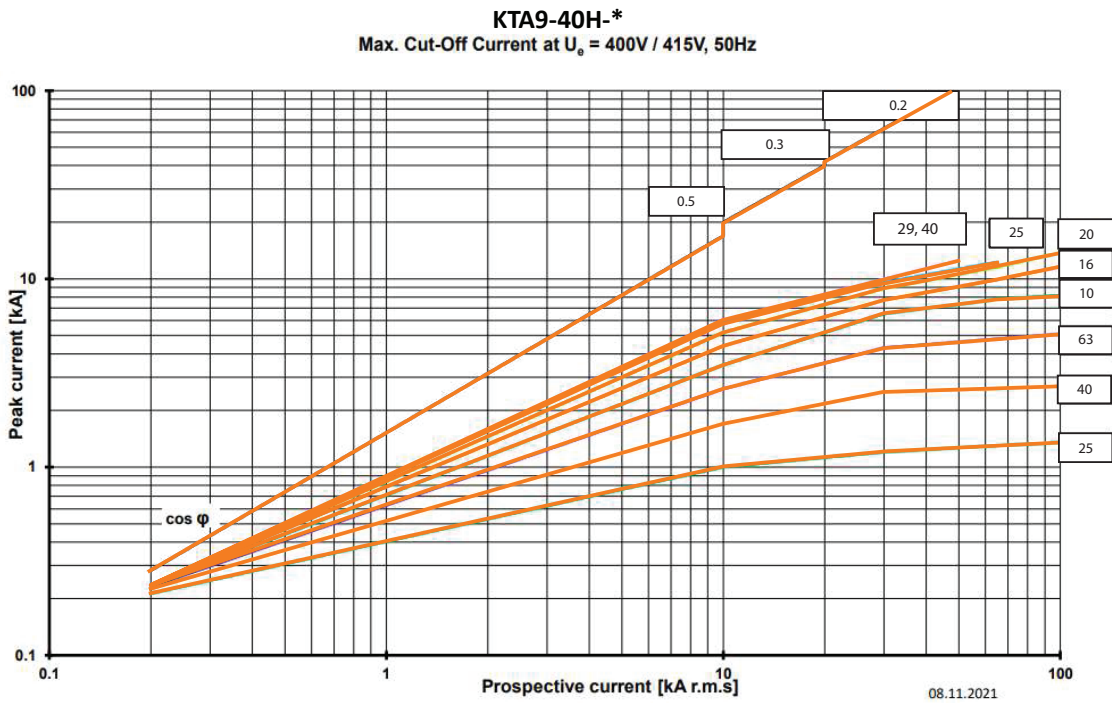

① A full size (8-1/2 x 11) set of "Maximum Cut-Off Current (Let-Thru Current)" and "Maximum Let-thru Energy (I²t)" curves for 400...415V, 500V and 690V can be downloaded from <http://www.sprecherschuh.com>.

Approximate Dimensions

KT_9 Devices and Accessories – Mounting Orientation

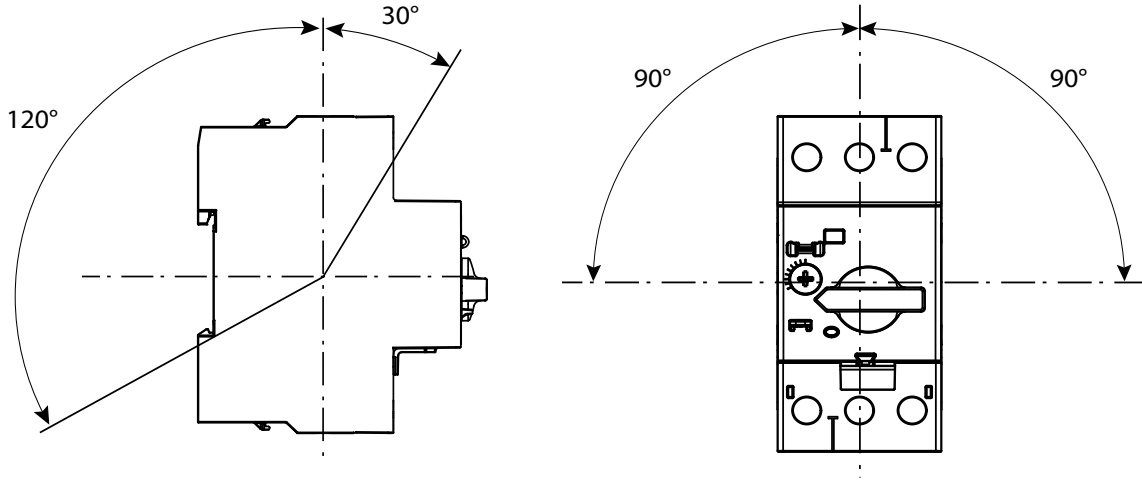

KT_9 Devices and Accessories – Spacing Requirements

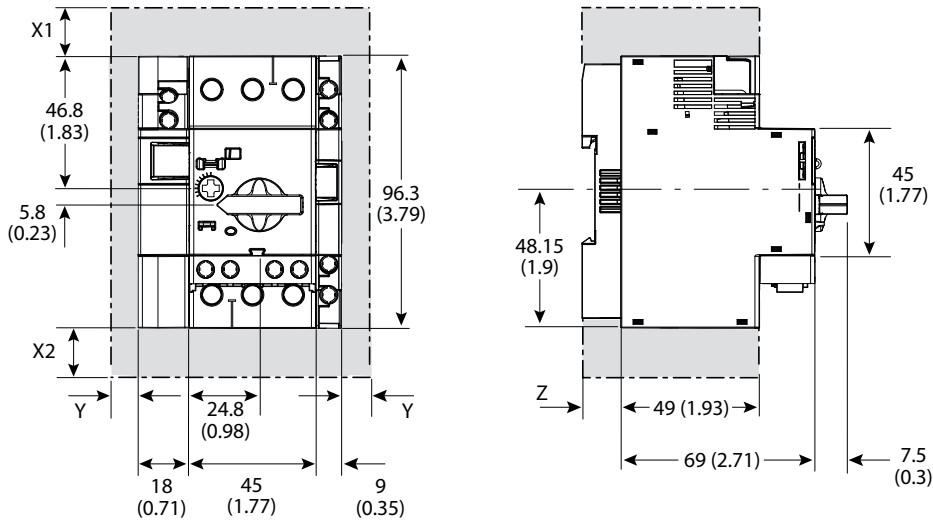

Frame Size	Voltage [V AC]	Minimum Distance to Grounded Parts or Walls [mm (in)]			Z
		X1	X2	Y	
KTA9-32S (C-Frame)	400	30 (1-3/16)	30 (1-3/16)	9 (23/64)	7.5 (19/64)
	500	30 (1-3/16)	30 (1-3/16)	9 (23/64)	
	690	50 (1-31/32)	50 (1-31/32)	30 (1-3/16)	
KT_9-40H (D-Frame)	400	30 (1-3/16)	30 (1-3/16)	9 (23/64)	13.5 (17/32)
	500	30 (1-3/16)	30 (1-3/16)	9 (23/64)	
	690	50 (1-31/32)	50 (1-31/32)	30 (1-3/16)	

❶ A full size (8-1/2 x 11) set of "Maximum Cut-Off Current (Let-Thru Current)" and "Maximum Let-thru Energy (I²t)" curves for 400...415V, 500V and 690V can be downloaded from <http://www.sprechersschuh.com>.

Motor Protection Circuit Breaker (C-Frame), Cat. No. KTA9-32S...

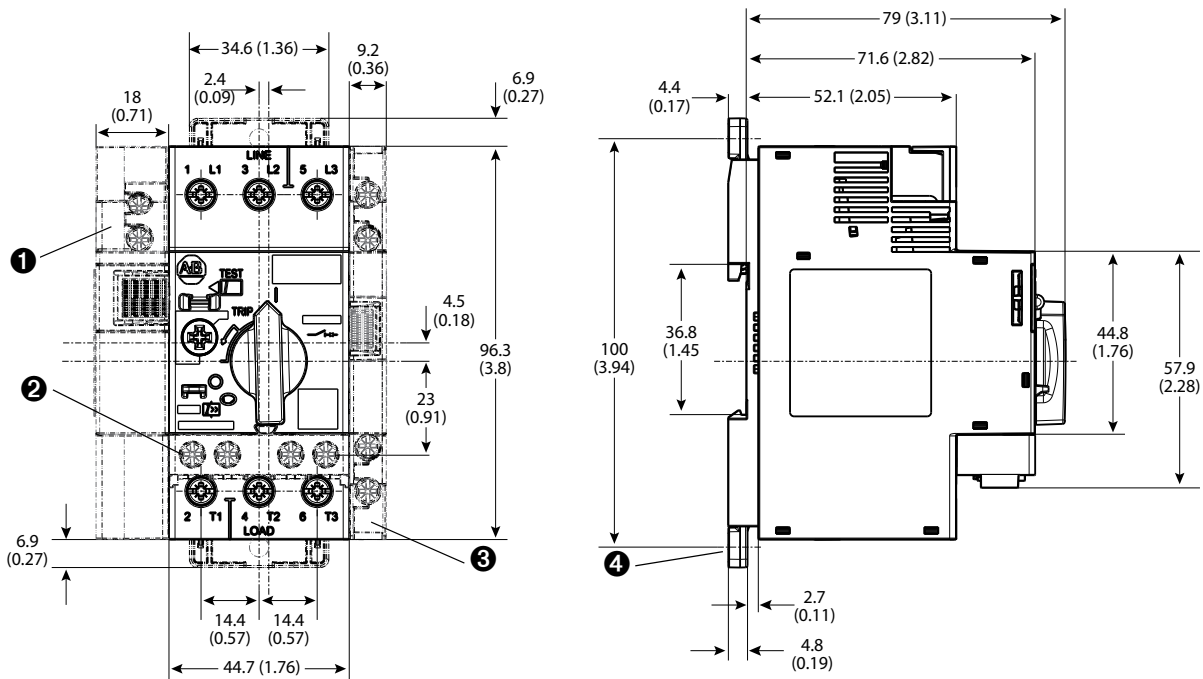

Motor Protection Circuit Breaker (D-Frame), Cat. No. KT_9-40H...

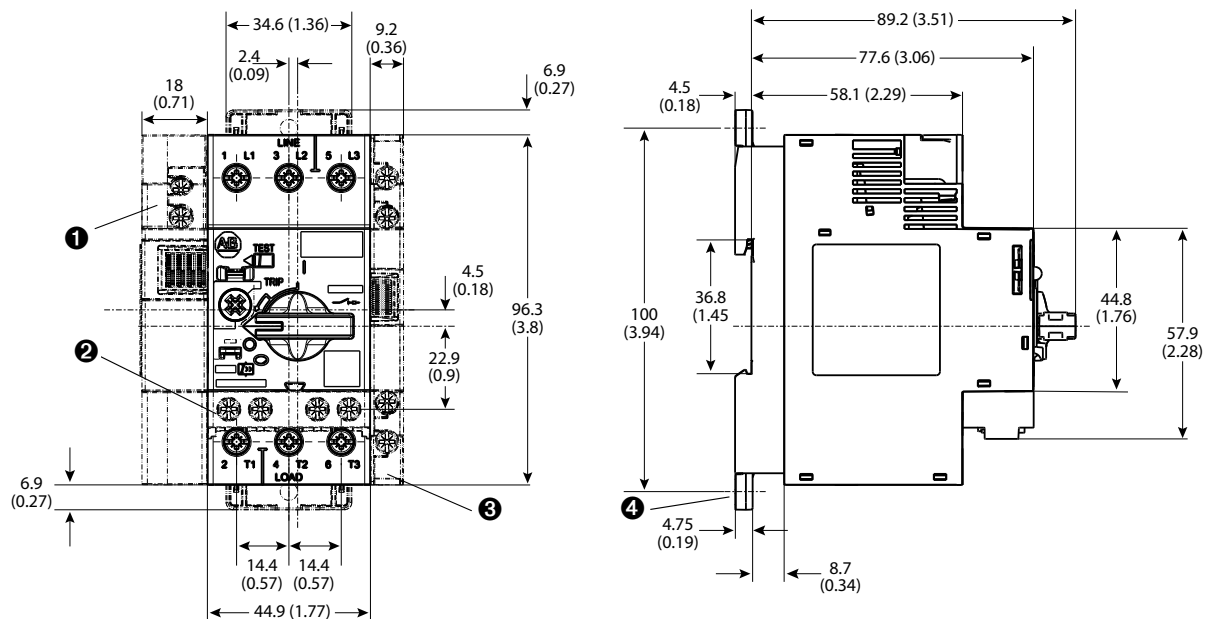

- ❶ Undervoltage/shunt trip
- ❷ Auxiliary contact (front mounted)
- ❸ Auxiliary contact (side mounted)
- ❹ Screw mounting adapter

F
KT9 Motor Circuit Controllers

Feeder Terminal for Compact Busbar, Cat. No. KT9-40-A3E

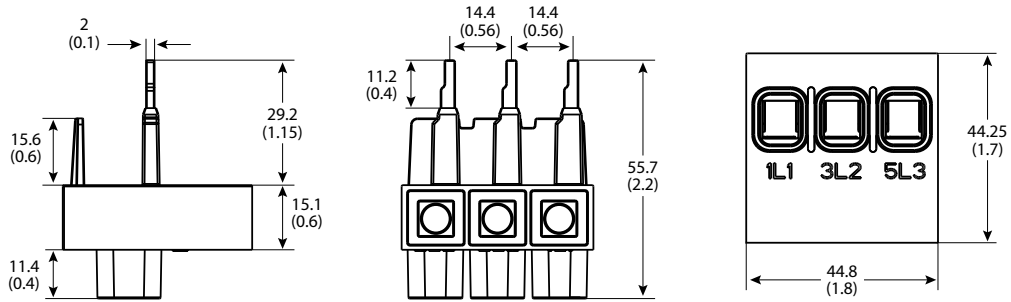

Terminal Cover, Cat. No. KT9-40-DBA

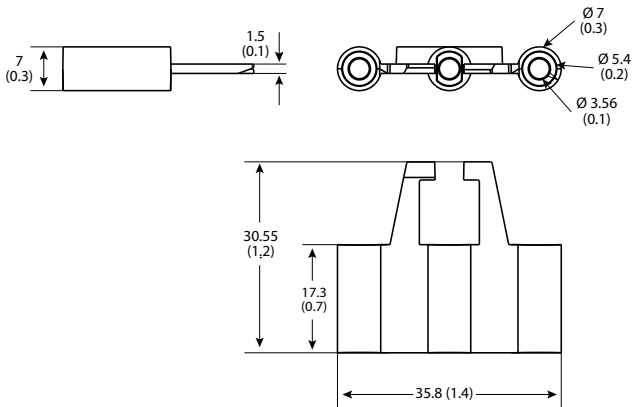

Supply Block, Cat. No. KT9-40-A2E

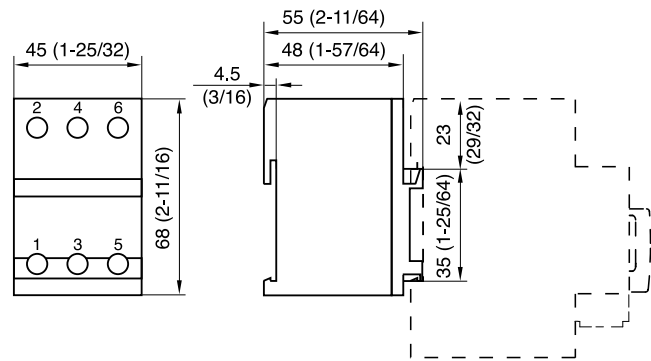

KT9-40-TE Type E adapter on Cat. No. KTA9-32S and KT_9-40H...

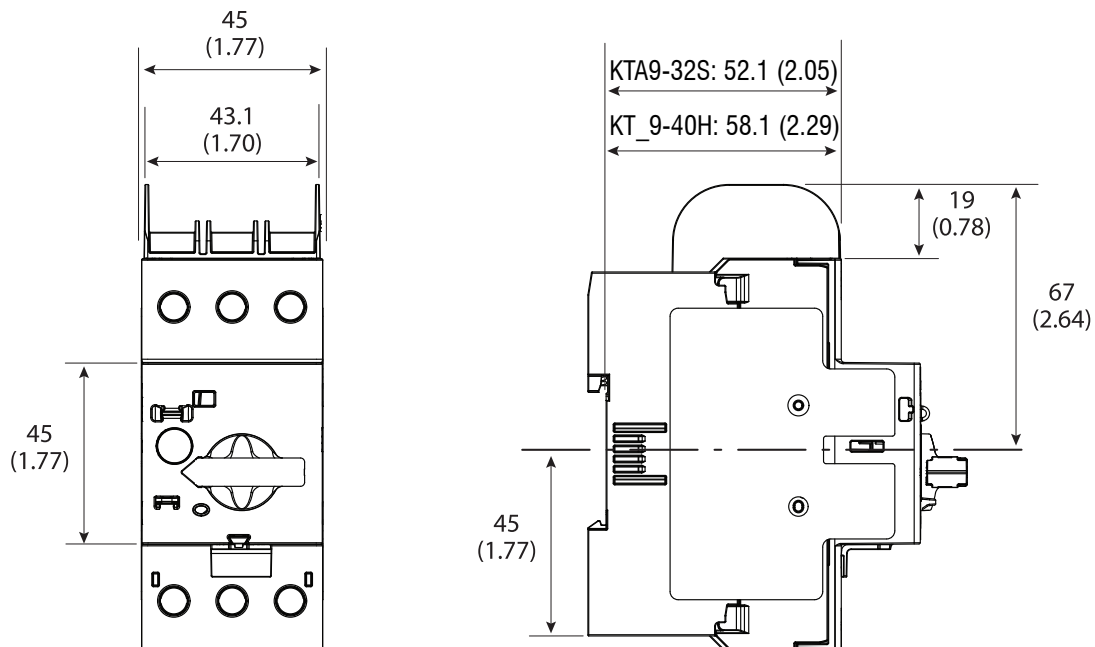

F

KT9 Motor Circuit Controllers

KT_7-45H Mounting Position / Safety Clearance

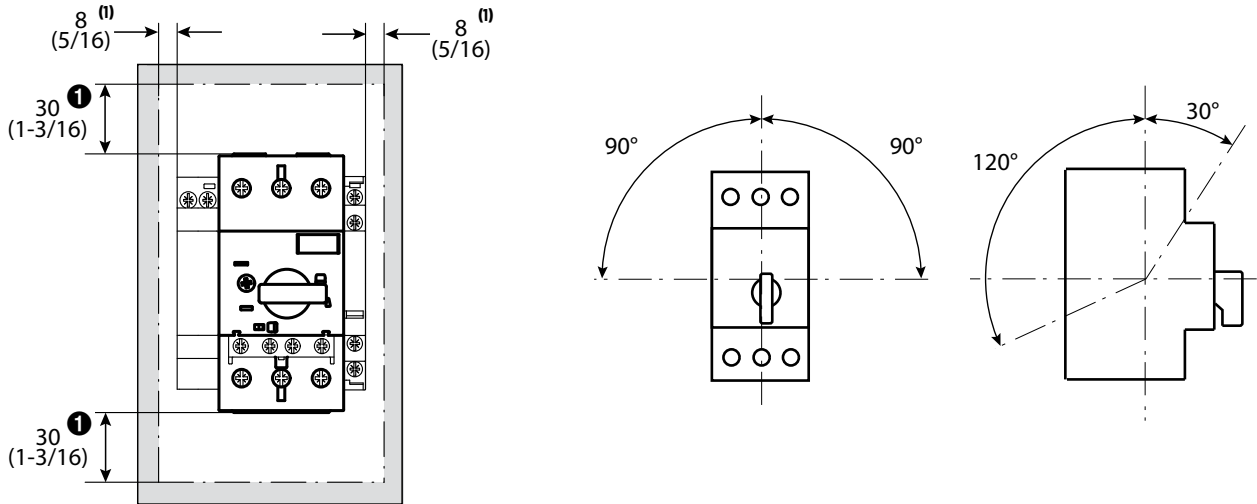

Motor Protection Circuit Breaker (F-Frame), Cat. No. Cat. No. KT_7-45H...

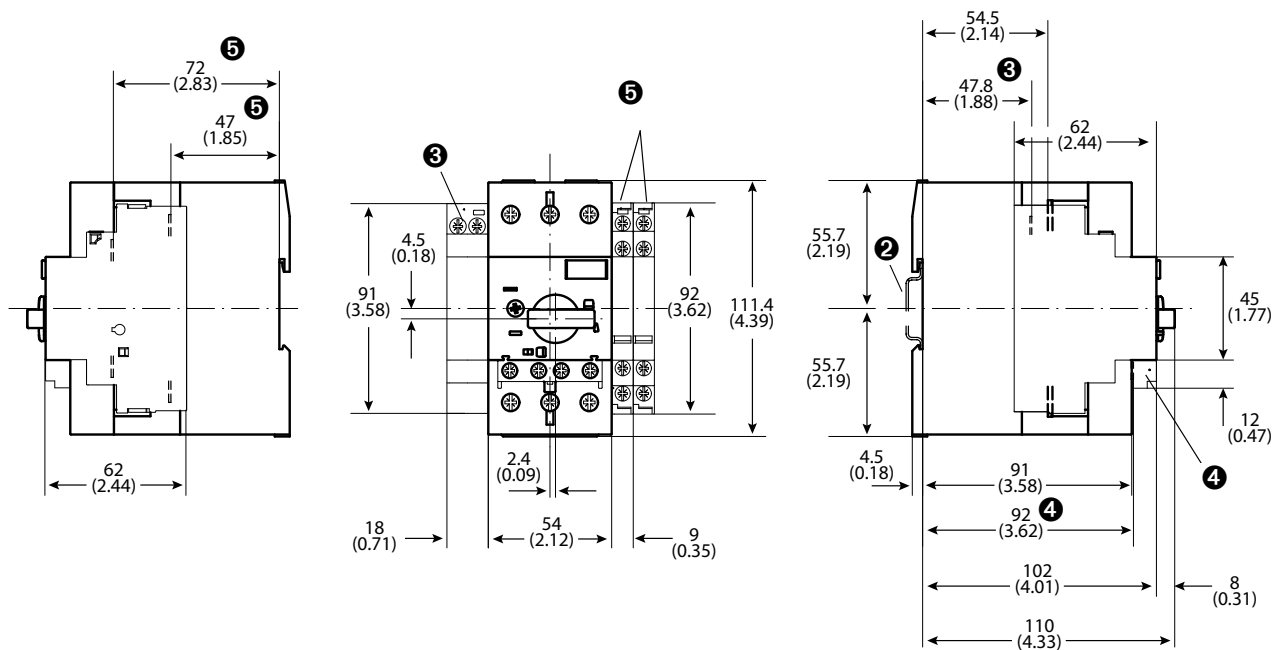

- ❶ Minimum distance to grounded parts or walls
- ❷ Mounting on 35 mm DIN Rail
- ❸ Undervoltage/shunt trip

- ❹ Auxiliary contact (front mounted)
- ❺ Auxiliary contact (side mounted)

KT7-45-TE Type E adapter on Cat. No. KT_7-45H...

Dimensions are in millimeters (inches). Dimensions not intended for manufacturing purposes.

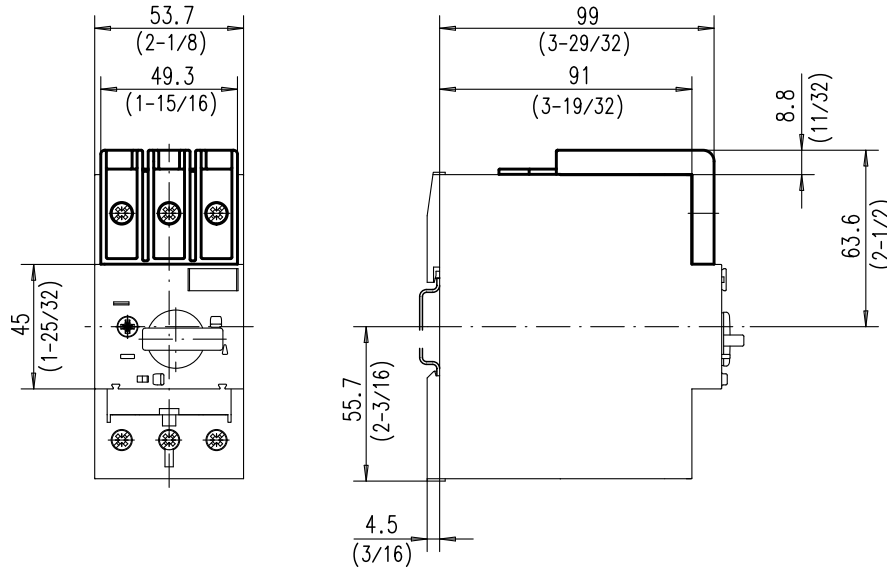

Screw Adapter, Cat. No. KT7-45-AS

